

SPRINGVILLE CITY ELECTRICAL REQUIREMENTS & STANDARDS MANUAL

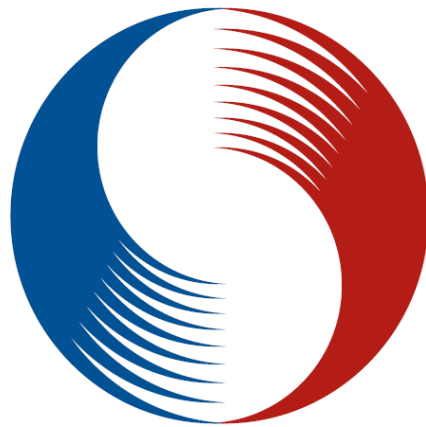

Springville

Community. Service. Reliability.

SPRINGVILLE CITY POWER DEPARTMENT

EFFECTIVE AS OF FEBRUARY 1, 2008, REVISED JULY 1, 2013
STANDARDS ARE SUBJECT TO REVIEW

[Click section in the table of contents to navigate to desired section.](#)
[Click "zoom to table of contents" in upper right hand corner to return to this page.](#)

SPRINGVILLE CITY ELECTRICAL REQUIREMENTS & STANDARDS MANUAL TABLE OF CONTENTS

Section 1 – General Requirements

Purpose.....	1.1
Codes and Ordinances.....	1.1
Changes or Conflicts in Requirements and Guidelines	1.1
Application for Service	1.2
Types of Service Furnished	1.2
Overhead Service	1.2
Underground Service	1.2
Approval for Service.....	1.2
Permanent Service Connection	1.3
Seals	1.3
Work Activity near High Voltage Overhead Power Lines	1.3
Underground Primary/Secondary System Requirements of Subdivision and Commercial Areas.....	1.4
General.....	1.4
Application.....	1.4
Developer Responsibility.....	1.4

Section 2 – Trenching and Conduit

Scope.....	2.1
General.....	2.1
Trenching	2.1
Call Before You Dig	2.1
Depth.....	2.1
Width.....	2.2
Backfill.....	2.2
Joint Use.....	2.2
System Joint Use Trench	2.3
Secondary Residential Trench	2.4
Residential Conduit Requirements	2.4
Primary System Trench.....	2.4
Secondary and Street Lights in System Trench	2.5
Conduit.....	2.5



SPRINGVILLE CITY ELECTRICAL REQUIREMENTS & STANDARDS MANUAL TABLE OF CONTENTS

TABLE OF CONTENTS 1
ELECTRICAL STANDARDS
SCALE: NONE
DATE: 8.23.07
REV:
REV DATE: 7.16.2013

Backfill.....	2.7
Burial Depth.....	2.8
Directional Bore.....	2.9
Section 3 – Residential Services	
General.....	3.1
Meter Socket Installation	3.2
Overhead Service	3.3
Underground Service	3.4
Customer Responsibilities –	
Single-Family Underground Service Requirements	3.5
Installation of Underground Service Extension.....	3.7
Service Trench Detail	3.8
Section 4 – Secondary Junction Boxes	4.1
Section 5 – Pad Mounted Transformers	
Single-Phase Pad Mounted Transformers.....	5.1
Single-Phase Typical Conduit Installation	
For Residential Subdivisions	5.2
Single-Phase Transformer Pad or Secondary Junction Box Location	
With Planter and Sidewalk.....	5.3
Single-Phase and Three-Phase	
Pad Mounted Transformer Clearances.....	5.4
Equipment Erosion Prevention	5.5
Three-Phase Transformer Concrete Pad without CT Rack.....	5.6
Three-Phase Transformer Pad with Metering Station	5.7
Section 6 – Street Lighting	
General.....	6.1
Street Light Layouts.....	6.1
Point(s) of Delivery for Decorative Lighting.....	6.2
Street Lighting Conduit Requirements	6.3
Springville City Power Standard Street Lights.....	6.3
Decorative Street Lights	6.3
Typical Street Lighting Layout.....	6.4
Street Light Wiring	6.5
Section 7 – Sectionalizers and Switches	
Conduit Placement for Sectionalizers.....	7.1
Conduit Placement for Switches.....	7.2



**SPRINGVILLE CITY
ELECTRICAL REQUIREMENTS
& STANDARDS MANUAL
TABLE OF CONTENTS**

TABLE OF CONTENTS 2
ELECTRICAL STANDARDS
SCALE: NONE
DATE: 8.23.07
REV:
REV DATE: 7.16.2013

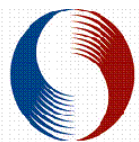

Springville
Community. Service. Reliability.

**SPRINGVILLE CITY
ELECTRICAL REQUIREMENTS
& STANDARDS MANUAL
TABLE OF CONTENTS**

TABLE OF CONTENTS 3

ELECTRICAL STANDARDS

SCALE: NONE

DATE: 8.23.07

REV:

REV DATE: 7.16.2013

Section 8 – Developer Overview

Scope.....8.1

Basic Guidelines8.1

Section 9 – Temporary Power/Service9.1

Section 10 – Residential Electrical Inspection Requirements10.1

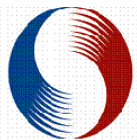

Springville

Community. Service. Reliability.

**SPRINGVILLE CITY
ELECTRICAL REQUIREMENTS
& STANDARDS MANUAL
TABLE OF CONTENTS**

TABLE OF CONTENTS 4

ELECTRICAL STANDARDS

SCALE: NONE

DATE: 8.23.07

REV:

REV DATE: 7.16.2013

GENERAL REQUIREMENTS

Purpose

This section was prepared to aid developers, contractors, engineers and customers in establishing electric service point: ***Springville City service point of utility for connection to Springville Power will terminate at the point of connection immediately adjacent to overhead service masts (weather head) and on the meter terminals for underground services***, for new and remodeled structures. We recognize that you may require personal assistance from our staff, and we encourage you to contact us by calling Springville City Power to discuss electric service requirements with us. It is the desire of Springville City Power, and the local electrical code enforcing authority to provide you, the Customer (developers, contractors, owners, etc.) with high quality, safe electric service.

In order to avoid unnecessary repetition, the "Power Department" as used in the following pages shall mean Springville City Power Department.

The requirements are intended to apply to new developments.

As a general rule, if the matter in question is not presented herein, then it is not allowed unless approved by the Power Department.

Any power required for private use (i.e. light, sprinkler, etc.) shall be metered.

Codes and Ordinances

It is necessary that the construction of new or remodeled installations conform to applicable provisions of the National Electrical Code (NEC), National Electrical Safety Code (NESC), and State of Utah Electrical Service Regulations, as well as City and County ordinances and codes. This includes OSHA rules both during construction and maintenance.

Changes or Conflicts in Requirements and Guidelines

Some of the information in this section is based on the aforementioned governmental codes and ordinances as well as Springville City Power specific requirements as stated herein. These requirements and guidelines are issued with the intent of complying with all applicable codes, ordinances, regulations, and tariffs; however, in the case of conflict, the appropriate regulation, tariff, code, or ordinance will supersede the interpretation offered in this manual. In addition, these requirements are subject to change in the event that the governing codes, ordinances, regulations, or tariffs are changed. The Power Department should be consulted in case of doubt on the applicability of any item.

The phrase "consult Power Department" as used in this manual shall mean a consultation with Springville City Power Department Superintendent is to be made for each and every installation or project.



SPRINGVILLE CITY ELECTRICAL REQUIREMENTS & STANDARDS MANUAL GENERAL REQUIREMENTS

ELECTRIC 1.1
GENERAL REQUIREMENTS
SCALE: NONE
DATE: 8.22.07
REV:
REV DATE: 7.16.2013

|

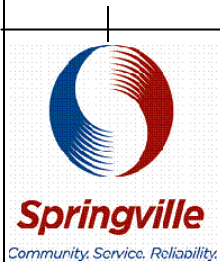

**SPRINGVILLE CITY
ELECTRICAL REQUIREMENTS
& STANDARDS MANUAL
GENERAL REQUIREMENTS**

ELECTRIC 1.2
GENERAL REQUIREMENTS
SCALE: NONE
DATE: 8.22.07
REV:
REV DATE: 7.16.2013

Application for Service

It is important that the Power Department office be provided as early as possible with accurate load information and the date when the Customer will require service, so all necessary arrangements for the service may be completed. Request for service to large residential developments normally require 60 days advance planning by the Power Department in order to serve the load. Installations requiring transformers or other equipment not in stock may require six months lead time or more.

The Power Department is available to provide advice on service requirements and related problems relative to electric energy utilization for new, existing, and reconstructed installations. The Developer will be held liable for any damage to Power Department equipment.

When conditions are encountered during construction that require changes in the initial, agreed upon service arrangements, the Power Department must be consulted so mutually satisfactory alternative arrangements can be made. Adequate notice must be given to the Power Department and approval granted regarding changes or additions.

Types of Service Furnished

The electric service available is 60 Hertz (cycles), alternating current, single or three-phase. The secondary voltages and connections available are given below:

Overhead Service

No single-phase overhead services in excess of 150 Amps.

Underground Service

- Single-phase, 120/240 volt, three-wire, grounded
- Three-phase, 120/208Y volt, four-wire, grounded wye
- Three-phase, 277/480Y volt, four-wire, grounded wye

The nominal primary voltage of Springville City's power distribution system does not differ in the service area. Under certain conditions, primary delivery will be supplied at the distribution voltage standard for the location at which it is requested upon approval of the Power Department.

Approval for Service

It is required that an electrical installation be approved by the electrical inspection authority having jurisdiction and by the Power Department, as stated herein, before it can be energized by the Power Department. The service will be energized by the Power Department only after all service requirements and inspections have been met. All electrical services are required to have an exterior main disconnect.



SPRINGVILLE CITY ELECTRICAL REQUIREMENTS & STANDARDS MANUAL GENERAL REQUIREMENTS

ELECTRIC 1.3
GENERAL REQUIREMENTS
SCALE: NONE
DATE: 8.22.07
REV:
REV DATE: 7.16.2013

Permanent Service Connection

Only authorized Power Department employees shall make the permanent (or temporary) connection or disconnection of the Power Department's electric service to a building, structure or subdivision interconnections.

Seals

The purpose of seals by the Power Department on meters and associated service equipment is to prevent injury and/or tampering. A fee will be charged for any cut seals. All tampering and theft of power will be investigated and prosecuted per Springville City code.

Under normal circumstances, seals are not to be removed except by the Power Department. If an emergency should require seal removal (only by authorized electrical contractors) without prior notification, the Power Department must be notified as soon as possible, so the installation can be inspected and the seal replaced. When this occurs, the party removing the seal shall accept all liability for damage or alteration to equipment, injury to persons or property, and loss of revenue to the Power Department from the time the seal is removed until 72 hours after the Power Department has been notified that the equipment is ready to be re-sealed.

Work Activity near High Voltage Overhead Power Lines

As set forth in Section 54-8c-1 through 54-8c-7 of the Utah Code, no person or thing may be brought within 10 feet of any high voltage overhead line unless:

The responsible party has notified the Power Department or Utility operating the high voltage line of the intended activity; and

The responsible party and the Power Department or Utility have completed mutually satisfactory safety precautions for the activity; and

The responsible party has made prior arrangements to pay the Power Department or Utility for the mutually satisfactory safety precautions (if applicable).

The Power Department recommends a minimum of three business days' notice be given before any work near its lines is scheduled to begin.

NOTE: The National Electrical Safety Code requires that homes, buildings, bridges, signs, antennas, etc. have sufficient horizontal and vertical clearance to overhead power lines. Consult the Power Department for applicable distances.

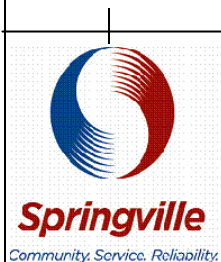

SPRINGVILLE CITY ELECTRICAL REQUIREMENTS & STANDARDS MANUAL GENERAL REQUIREMENTS

ELECTRIC 1.4
GENERAL REQUIREMENTS
SCALE: NONE
DATE: 8.22.07
REV:
REV DATE: 7.16.2013

Underground Primary/Secondary System Requirements of Subdivision and Commercial Areas

General

The intent of this policy is to set forth the Developer's installation requirements and to outline specific installation standards. Along with requirements indicated in this section applicable requirements as indicated in other sections of this document apply to commercial and residential developments.

Where a development within the service area of the City is to be subdivided into residential or commercial lots and has been approved by the appropriate Planning and Zoning Boards, the electrical distribution system will be installed underground in accordance with the City's connection fee resolution and line extension policy. The subdivision Developer shall provide the City with the easements necessary for the most efficient installation of the required distribution system. All electrical systems installed by the Developer shall be front lot construction unless otherwise approved by the Springville City Power Department.

The following subsections serve as a guide for specific requirements of commercial and residential developments; however, the developer is responsible for coordinating with the Power Department to insure that the intents of this policy are met.

Application

For commercial, industrial, residential subdivisions, mobile home parks, and apartment complex applications, the request for service shall include a plot plan indicating equipment size. Commercial or industrial plot plans should show preferred service and meter locations and a single-line diagram of the overall electrical system. The request must show all load information for commercial developments. Load information should include lighting, receptacle, water heating, cooking, electric heat, air conditioning, and motor loads, plus sufficient information on equipment operations to allow the kilowatt demand of the load to be estimated. The Power Department shall review the drawings and return the drawing set marked "Approved" or "Unapproved" with an indication of required changes.

Developer Responsibility

1. Provide and install all power conduits for primary, secondary and street lighting circuits. All conduits shall be of a SCH 40 PVC rating. All conduits shall be installed at the required depths for type of circuit. All trench depths and conduits must be inspected by the Department before being backfilled. Backfill trenches according to trenching detail. Complete all inspections including all road crossing installations.



SPRINGVILLE CITY ELECTRICAL REQUIREMENTS & STANDARDS MANUAL GENERAL REQUIREMENTS

ELECTRIC 1.5
GENERAL REQUIREMENTS
SCALE: NONE
DATE: 8.22.07
REV:
REV DATE: 7.16.2013

2. Provide and install all 90° rigid steel elbows with 10 mil tape. All 3-phase and 1-phase primary circuit conduits require the 36 inch sweep elbow. Any secondary circuit that is greater in length than 300 feet must be terminated with a rigid steel sweep elbow.
3. Provide materials for a riser pole if required. Must install the first 10 foot section of rigid or IMC conduit on standoff on the pole. Must use a 10 mil taped 90° rigid steel sweep at the pole. The department will finish installation with the materials provided by the developer to the point of termination.
4. A mule tape pull line of at least 2550 lbs. pulling strength shall be installed in all conduit lengths and secured at both ends. Ends of conduits shall be taped and sealed to prevent unwanted material entering. For residential service drops a 500-pound test or greater pull line shall be left in the conduit with at least 6 feet of line extending from each end.
5. All conduits shall terminate 3 to 6 inches above grade in junction boxes and ground sleeves. Identify with red paint on the conduit ends all primary conduits in the transformer ground sleeve.
6. Install all primary junction ground sleeves provided by the Department for the development.
7. Install all transformer ground sleeves provided by the Department for the development. Transformer ground sleeves shall be a minimum of 3 inches above the back of the sidewalk on compacted road base material.
8. Install all secondary junction boxes provided by the Department for the development. Secondary junction boxes shall be a minimum of 1 inch above the back of the sidewalk.
9. Install all required street lighting conduit at the required depth of the secondary conduit trench detail and junction boxes provided by the Department for the development.
10. The developer will be responsible for all equipment replacement even after cable is installed until all construction is completed and a final inspection is done to sign off on the bond assessment. Developer will sign a letter of material acceptance when materials are delivered and shall be responsible for all loss from the day that materials are on site.
11. URD cable will not be installed until curb and sidewalk are in place so that elevations of all power equipment will be correct. If not, all costs of relocation of facilities will be at the developer's expense. This will include installation of ground sleeves, junction boxes, and all other equipment.
12. No excavation is allowed until the curb and gutter is installed and the final grade is determined.
13. All workmanship is expected to be done with the highest of professional standards.

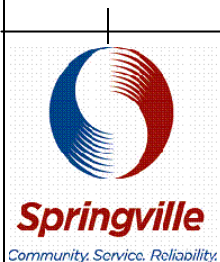

**SPRINGVILLE CITY
ELECTRICAL REQUIREMENTS
& STANDARDS MANUAL
GENERAL REQUIREMENTS**

ELECTRIC 1.6
GENERAL REQUIREMENTS
SCALE: NONE
DATE: 8.22.07
REV:
REV DATE: 7.16.2013

TRENCHING & CONDUIT

Scope

This standard describes trench requirements for underground primary and secondary distribution cable systems, including joint use with telephone or CATV cables and conduits.

General

All other circuits installed in any trench containing Springville City Power (SCP) distribution circuits shall maintain the minimum 12 inch separation required by the current edition of the National Electric Safety Code Article 352.

Where trenching is provided by a contractor or customer, inspection of the trench and of conduits by SCP personnel shall be made prior to the installation of the select backfill.

Where county, state or other regulatory agency joint use, trench, backfill or compaction requirements exceed the requirements of SCP, the more stringent requirements shall apply. In no case shall this standard be used as justification to ignore or violate local regulations.

Trenching

The developer is to provide the trench for all required conduit systems and, following installation of the conduit by the Developer, backfill to meet Power Department requirements. The Power Department, under the terms of the City's Line Extension New Connection policy (Resolution 97-12), will install both primary cables (medium voltage 12.47 kV or 4.16 kV) and secondary cables (480 Volts and below).

To assure the final grade has been established, the trenching will be started after the curbs and gutters have been installed unless approved by SCP.

Call Before You Dig

Utah Law Section 54-8A-1 through 54-8A-11 requires the Blue Stakes One Call Location Center be notified at least two working days prior to excavation. The excavation must not be started until locations have been made. Blue Stake One Call Location Center can be contacted by calling either 811 or 1-800-662-4111.

Inspection Fees

The first two trench inspections will be at no cost; all inspections after that will be \$50.00 per inspection.



SPRINGVILLE CITY ELECTRICAL REQUIREMENTS & STANDARDS MANUAL TRENCHING & CONDUIT

ELECTRIC 2.1
TRENCHING & CONDUIT
SCALE: NONE
DATE: 8.27.07
REV: Two (2)
REV DATE: 7.16.13

Depth

See chart on Figure 1 for trenching depths. The property owner is responsible at his own cost to insure that the proper burial depth clearance listed below is maintained even after excavation of the property. Any questions on impaired burial depths should be immediately brought to the attention of the Power Department. Under certain conditions, with prior Power Department approval, cable/conduit systems may be buried with less cover provided that mechanical protection is installed by the Developer to the Power Department’s specifications.

Width

All trenches meet OSHA requirements. Primary/secondary combined trenches shall be a minimum of 18 inches wide at the bottom. Conduit shall be placed in the center of the combined trench. All single primary trenches shall be a minimum of 18 inches at the bottom. House service trenches shall be a minimum of 12 inches wide at the bottom.

Backfill

The developer will be responsible for backfilling trenches he provides. The Developer must provide the required amount of sand to be placed below and above the conduit. A red caution ribbon stating “CAUTION POWER BURIED BELOW” shall be placed on top of the sand. Where trenches cross structural fill, typical of road crossings, the trench backfill shall consist of like kind structural fill. All primary trenches and all road crossing trenches (including trenches for secondary cable) shall be compacted to 95% compaction of the maximum dry density.

Joint Use

Typically, joint use between other utilities of power department trenches is not allowed unless approved by the Power Department. Any joint use between telephone, TV, and other electrical communication cables must be pre-approved by the Power Department and installed in accordance with the Power Department specifications. The Power Department normally will not install electrical cables in a common trench with non-electric utilities such as water, gas, and sewer, unless unusual conditions such as adverse soil or route restrictions exist. All such installations require the prior approval of the Power Department. All installation will comply with the current National Electric Safety Code (NESC).

	<p>SPRINGVILLE CITY ELECTRICAL REQUIREMENTS & STANDARDS MANUAL TRENCHING & CONDUIT</p>	ELECTRIC 2.2
		TRENCHING & CONDUIT
		SCALE: NONE
		DATE: 8.27.07
		REV: Two (2)
		REV DATE: 7.16.13

System Joint Use Trench

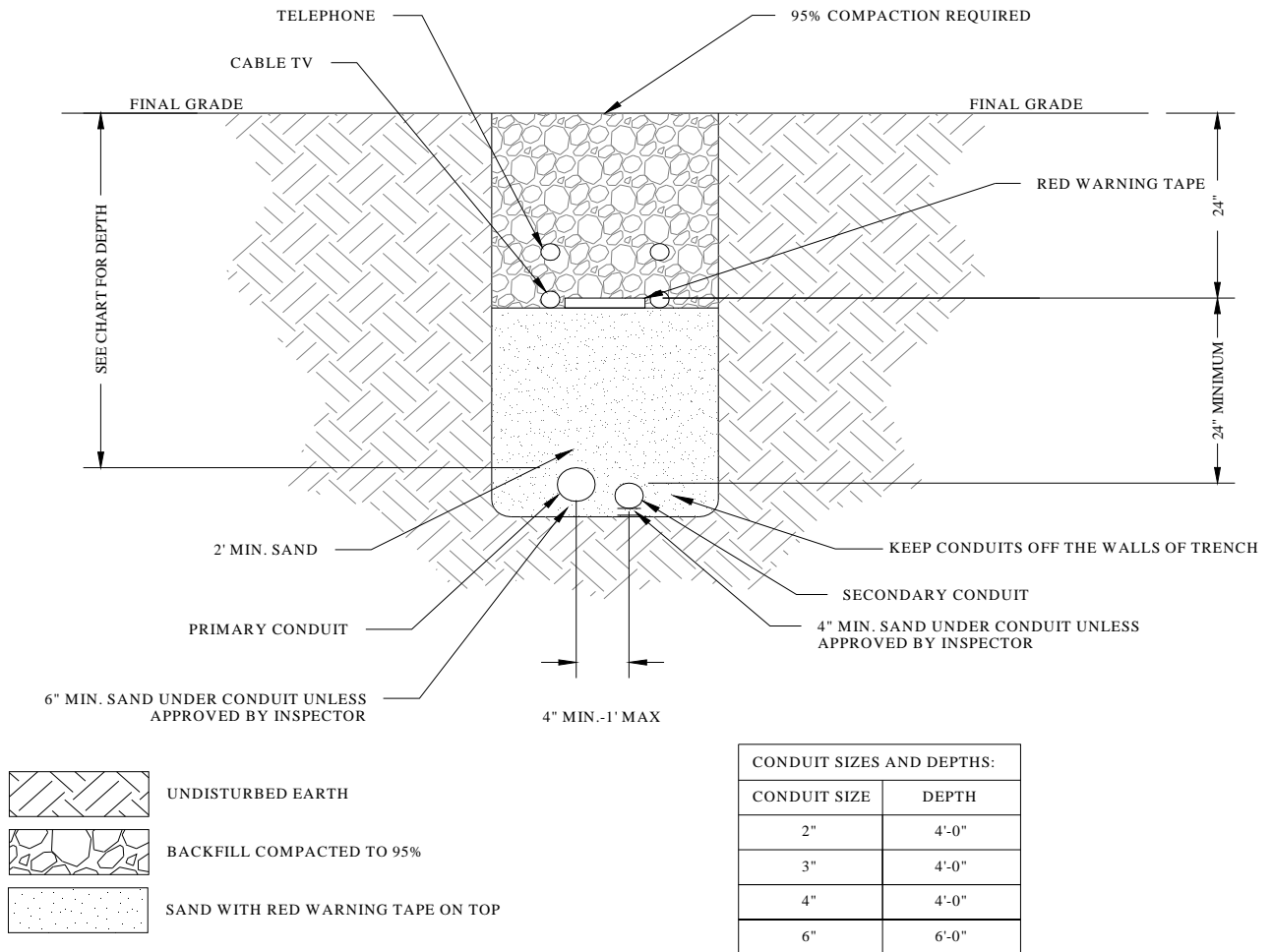

Figure 1 – Trench Cross Section



SPRINGVILLE CITY ELECTRICAL REQUIREMENTS & STANDARDS MANUAL TRENCHING & CONDUIT

ELECTRIC 2.3
TRENCHING & CONDUIT
SCALE: NONE
DATE: 8.27.07
REV: Two (2)
REV DATE: 7.16.13

Secondary Residential Trench:

The top of the conduit must be a minimum of 2 feet below the top of the back of the curb, or the existing grade.

There must be 4 inches of sand under the conduit.

After the depth inspection has been passed, a second inspection is required to check for a minimum 1 foot of sand on top of the conduit along with a red caution ribbon stating “CAUTION POWER BURIED BELOW”. The entire trench must be level with sand.

The total bend on a single pull cannot exceed 360 degrees.

Residential Conduit Requirements:

For 100 to 150 Amp services 2 inch conduit is required with a trench of 12 inch minimum width.

For 200 Amp services 2 1/2 inch conduit is required.

For services larger than 200 Amps call the Power Department for conduit size.

Metallic elbows are required at the house end of the trench, wrapped with 10 mil corrosion proof tape to the point where the conduit leaves the earth. The metallic riser at the house shall also be taped to final grade, Plastic conduit not permitted for use as riser pipe

The total bend on a single pull cannot exceed 360 degrees.

Primary System Trench

A minimum of 4 feet deep and 24 inch wide trench from top of conduit to top back of curb, or final grade.

There must be 6 inches of sand under the conduit while maintaining final depth requirement.

After the depth inspection has been passed, a second inspection is required to check for a minimum 2 feet of sand on top of the conduit along with a red caution ribbon stating “CAUTION POWER BURIED BELOW”. The entire width of the trench must be level with sand.

Separation between electric conduits and other utilities in a joint trench is a minimum 2 feet vertical.

All elbows are required to be wrapped metallic 36 inch style for the 3 inch single-phase primary.



**SPRINGVILLE CITY
ELECTRICAL REQUIREMENTS
& STANDARDS MANUAL
TRENCHING & CONDUIT**

ELECTRIC 2.4
TRENCHING & CONDUIT
SCALE: NONE
DATE: 8.27.07
REV: Two (2)
REV DATE: 7.16.13

Three-phase runs in 4 inch and larger conduit require the 36 inch long wrapped metallic sweeps.

When installing elbow at transformer, switch, or sectionalizer, the steel elbow will be placed at dirt level inside of electrical structure.

The total bend on a single pull cannot exceed 360 degrees.

Primary System Road Crossing:

Primary system road crossing must adhere to depth requirements. To meet road compaction requirements, 1 foot of sand is acceptable.

Secondary and Street Lights in System Trench:

Minimum of 4 feet deep from top of conduit to top back of curb, or final grade (will measure the lesser of the two).

There must be 4 inches of sand under the conduit.

Secondary conduit must be 3 inch with the exception of conduit for street lighting which shall be 2 inch.

Plastic elbows are only allowed when there are no more than 2 elbows, and the pull is less than 200 feet (2 lots long).

Wrapped rigid metallic elbows are required on pulls greater than 200 feet or pulls with more than 2 elbows.

Conduit

The Power Department requires the use of conduit for all underground primary and secondary cable installations, including lighting circuits. Rigid galvanized steel, IMC and gray electrical grade PVC schedule 40 (underground only) conduit are acceptable materials for conduits installed by the Customer or Developer. Plastic conduit not permitted for above ground riser pipes.

Rigid steel conduit is constructed of galvanized steel and uses threaded connections. It is stronger than other standard conduit materials and is suitable for applications requiring either conductive metal or high strength. Rigid steel conduit increases the reactance of cable installed in the conduit, which increases voltage drop. Rigid steel conduit must be effectively grounded.



**SPRINGVILLE CITY
ELECTRICAL REQUIREMENTS
& STANDARDS MANUAL
TRENCHING & CONDUIT**

ELECTRIC 2.5
TRENCHING & CONDUIT
SCALE: NONE
DATE: 8.27.07
REV: Two (2)
REV DATE: 7.16.13

Table 1 has conduit sizes used with standard primary, secondary, and service cables.

Conduit Trade Size (inches)
2
2 ½
3
4
6

Table 1 – Conduit Size

All conduit used for underground services will be sized by SCP at the time of application.

- 100 to 150 Amps – 2 inch
- 200 Amps – 2 ½ inch
- 300 Amps – 3 inch
- 400 Amps – 4 inch

All services larger than 400 Amps will require an instrument transformer cabinet. The cabinet will be installed by the contractor or homeowner to the National Electric Code and OSHA rules. SCP will help establish the location for this cabinet.

SCP will install all instrument transformers and test switches at the customer’s expense.

Business and/or Commercial customers will supply and install conductors for service as required by the NEC. Customer shall also provide termination lugs at the pad mount transformer.

Cable pulls longer than 250 feet will need to be pulled by the residential customer.

All underground risers to the meter base will be installed by the homeowner or contractor. The riser will be anchored to the foundation above dirt level, and the clamp not to be connected to the taped sections of the riser pipe.

All underground primary voltage risers will have a 90-degree rigid steel bend with a minimum radius of 36 inches. Long sweep elbows are NOT required for residences.

All primary elbows are required to be steel wrapped with 10 mil non-corrosive tape.

All conduits shall be terminated at the open end with plastic bushings.

All below ground metallic conduit must be wrapped with corrosion tape suitable for the application.



**SPRINGVILLE CITY
ELECTRICAL REQUIREMENTS
& STANDARDS MANUAL
TRENCHING & CONDUIT**

ELECTRIC 2.6
TRENCHING & CONDUIT
SCALE: NONE
DATE: 8.27.07
REV: Two (2)
REV DATE: 7.16.13

Residential single phase primary conduit must be 3 inch. Secondary conduit shall be 3 inch from transformers to secondary junction boxes and as required by service size from the secondary junction box or transformer to the residence.

All conduit end points shall be sealed or taped to prevent debris from plugging the conduit. The Developer shall be responsible for cleaning or repairing conduits if the Power Department is unable to install or pull the service cable.

Along with conduits extending to secondary junction boxes, each transformer pad and secondary box shall have 10 foot conduit stub outs for interconnection to adjacent homes when required by Springville City Power.

Prior to backfilling, the Developer must notify the Power Department for an inspection, following the inspection the Power Department shall issue a notice to proceed, allowing backfilling.

Backfill

Whenever possible, the soil originally removed from the trench should be used as backfill after sand has been installed.

Sand primary conduits with 24 inches of sand over and 6 inches under with contractor installed red electrical warning tape on top of the sand.

Sand secondary conduits with 12 inches of sand over and 4 inches under with red electrical warning tape on top of the sand.

The sand fill will pass through a 1/4 inch sieve frame.

The sieved residue contains less than five percent rock solids by volume.

The backfill used in the remainder of the trench shall be free of rocks larger than 4 inches in diameter.

No material shall be placed in as fill when either material to be placed or material on which it is placed is frozen.

All trenches shall be backfilled within 48 hours after conduit is installed and notice to proceed is given. Grading shall be reasonably even and free from irregularities, and shall provide positive drainage without ditching or ponding.

Final grade for cable depth purposes is at the bottom of the curb if a curb exists or is planned.

If the grade is to be lowered, the depth of cuts must be added to the specified trench depth.



**SPRINGVILLE CITY
ELECTRICAL REQUIREMENTS
& STANDARDS MANUAL
TRENCHING & CONDUIT**

ELECTRIC 2.7
TRENCHING & CONDUIT
SCALE: NONE
DATE: 8.27.07
REV: Two (2)
REV DATE: 7.16.13

Installation of circuits should be postponed in areas where significant changes of grade are anticipated until final grade is allowed to be determined.

Burial Depth

Under normal circumstances, the conduits shall be placed so as to meet or exceed the minimum depths shown in Table 2.

	Minimum Depth to Top of Conduit (inches)
Primary	48
Secondary	48
Residential Services, Stubs, and Drops	24
Street Lights	24

Table 2 – Minimum Depths for Trenching and Conduits

When trenching hillsides the top of the conduit must be 48 inches deep at the minimum depth and the bottom of the trench must be flat.

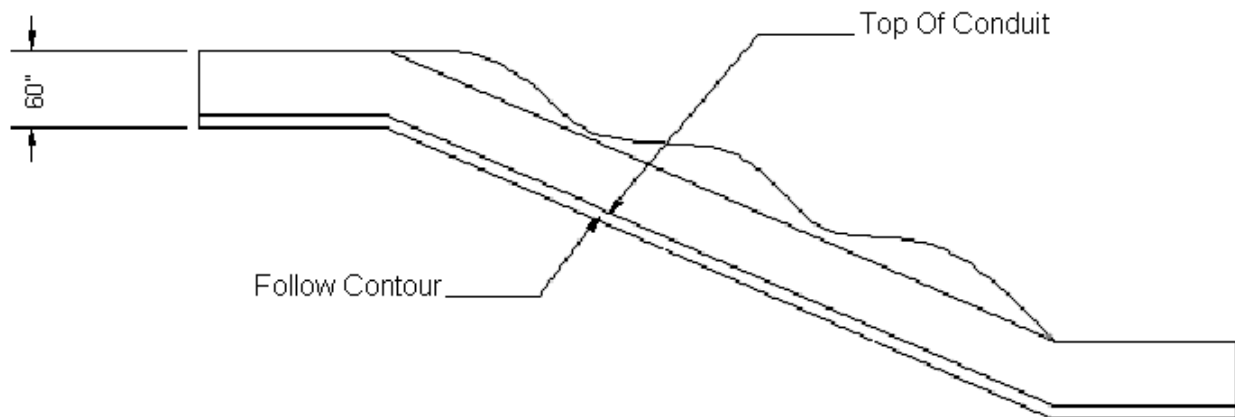

Figure 2 – Hillside Trench



**SPRINGVILLE CITY
ELECTRICAL REQUIREMENTS
& STANDARDS MANUAL
TRENCHING & CONDUIT**

ELECTRIC 2.8
TRENCHING & CONDUIT
SCALE: NONE
DATE: 8.27.07
REV: Two (2)
REV DATE: 7.16.13

Directional Boring Policy

Before a directional bore is attempted to install a power conduit, the contractor(s) doing the bore must contact the Power Department to conduct an on-site job briefing to discuss the work to be performed. Upon approval from the Power Department contractor(s) may be permitted to bore in underground electrical conduit when digging in a conduit is not feasible, or if property damage is a concern. A bore pit must be dug at the beginning, and at the end of a bore, to the correct depth depending on the voltage to be installed. The conduit must be either gray in color, or black with a red stripe, and must maintain a minimum depth for the length of the run; after conduit is installed a rigid wrapped metal sweep elbow must be installed on both ends of the conduit. If possible, the contractor(s) must write down the depth of the bore every fifteen (15) feet. If this can not be accomplished, a tracer wire must be installed to verify depth prior to Power Department accepting the power conduit.

NOTE: After fusing the HDPE conduit, the bead created from the fusion process must be reamed and removed from the inside of the HDPE conduit for a non-obstructed path before conductors can be installed.

Minimum Depth: Primary, 6' Secondary, 3'
 Approved Coupling: Shur-Lock II, or equivalent
 Conduit: HDPE 11. Must be gray, or black with a red stripe.

	SPRINGVILLE CITY ELECTRICAL REQUIREMENTS & STANDARDS MANUAL TRENCHING & CONDUIT	ELECTRIC 2.9
		TRENCHING & CONDUIT
		SCALE: NONE
		DATE: 8.27.07
		REV: Two (2)
		REV DATE: 7.16.13

RESIDENTIAL SERVICES

General

The Power Department will determine the exact location of meters that do not meet the criteria established in this manual. If the customer is unsure if the meter location is acceptable, the Power Department should be contacted.

The location of the electrical service point on the customer's premises is an important consideration. Consult the Power Department to determine the point of attachment for overhead service drops and underground service laterals.

Install residential meters outdoors at a location acceptable to the Power Department. Locate the meter within ten feet of the street side (front side) of the residence, on the side of the residence closest to the Power Department's source. Avoid installations near windows or exterior walls that are likely to be fenced in. Never install the meter over window wells, steps in stairways, or in other unsafe or inconvenient locations. Keep shrubs and landscaping from obstructing access to the meter.

Written approval from the Power Department is required, prior to installation, for alternative meter socket locations when:

1. Conditions prohibit placing the meter base within ten feet of the front of the building.
2. Alley-fed services have access for meter reading.
3. Metering pedestals or poles are used.
4. Other special conditions exist.

Figure 2 below shows where an overhead residential meter socket should be located.

	SPRINGVILLE CITY ELECTRICAL REQUIREMENTS & STANDARDS MANUAL RESIDENTIAL SERVICES	ELECTRIC 3.1
		RESIDENTIAL SERVICES
		SCALE: NONE
		DATE: 8.24.07
		REV: One (1)
		REV DATE: 7.9.13

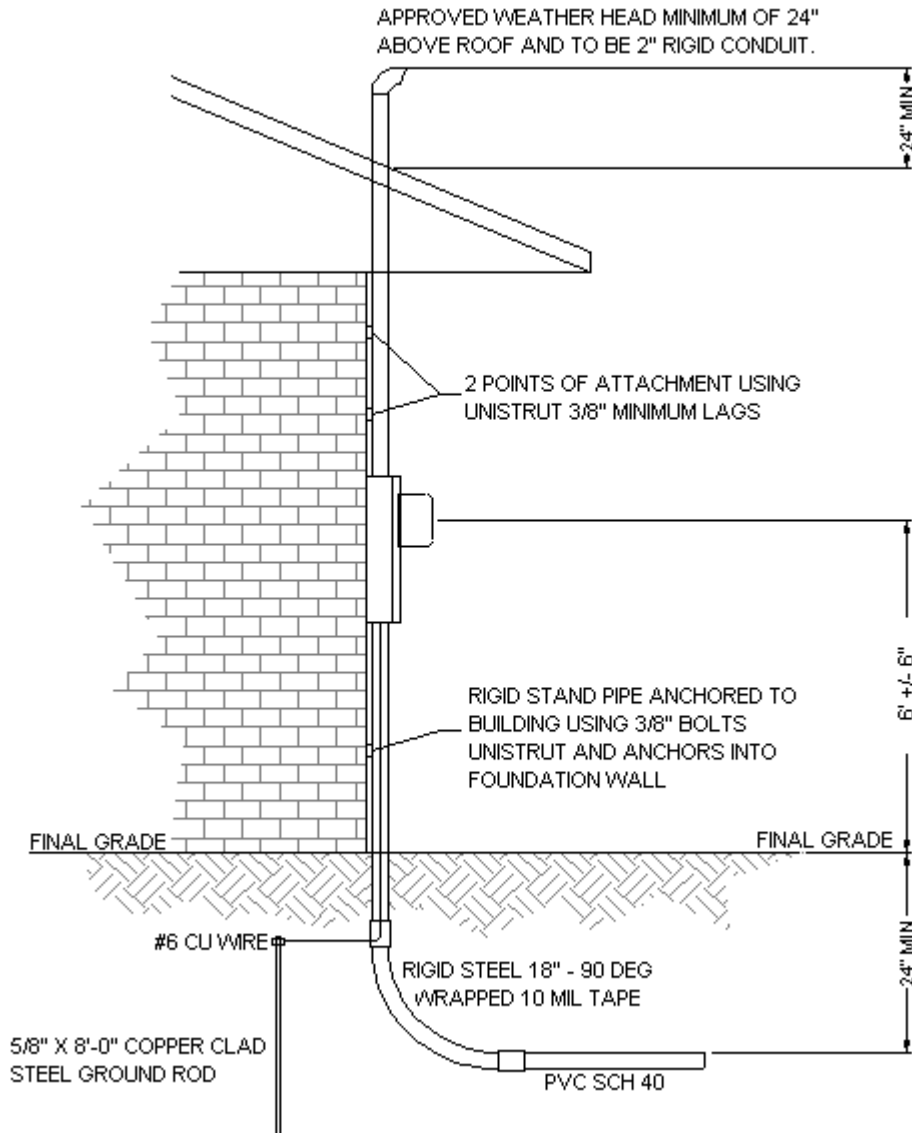

Figure 1 – Meter Socket Installation



SPRINGVILLE CITY
ELECTRICAL REQUIREMENTS
& STANDARDS MANUAL
RESIDENTIAL SERVICES

ELECTRIC 3.2
RESIDENTIAL SERVICES
SCALE: NONE
DATE: 8.24.07
REV: One (1)
REV DATE: 7.9.13

Overhead Electrical Service Point (150 amp or smaller, 200 amp aerial will not be accepted)

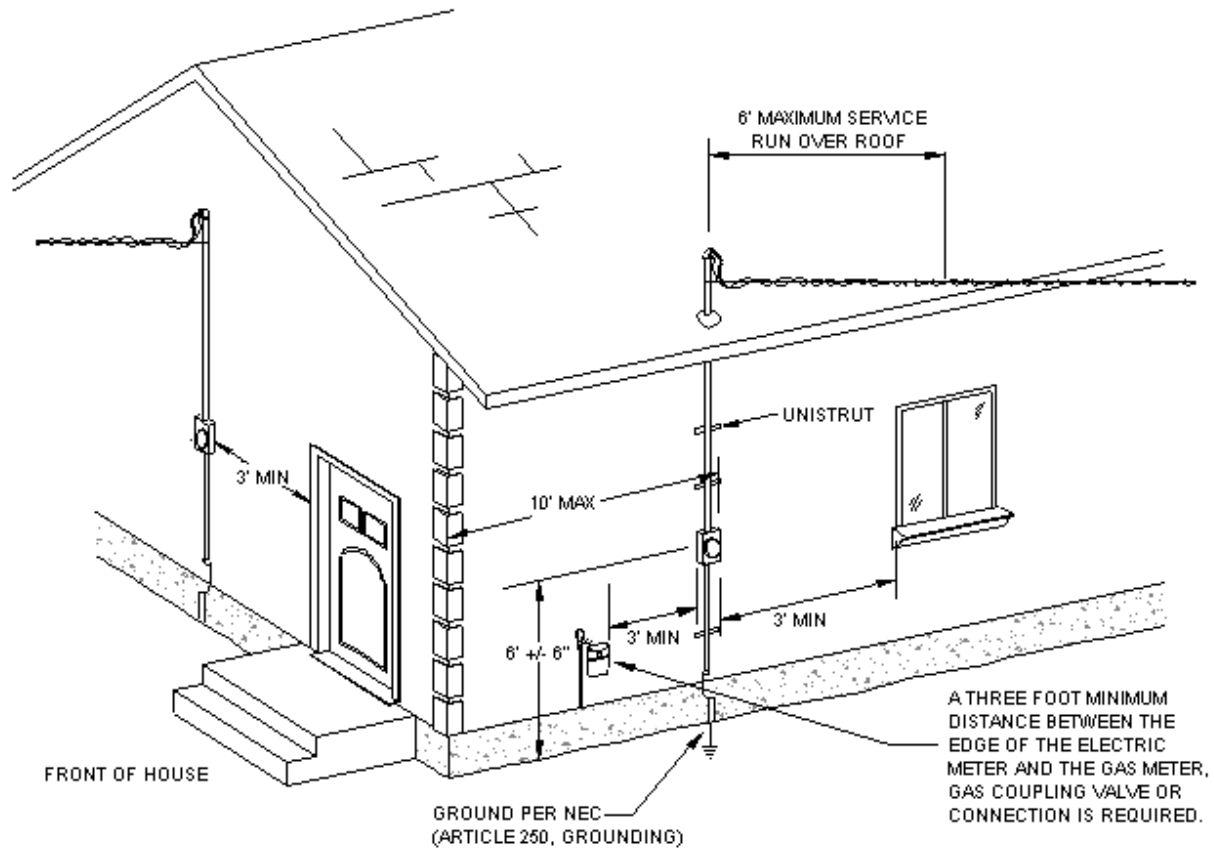

Figure 2 – Residential Meter Location for an Overhead Service



**SPRINGVILLE CITY
ELECTRICAL REQUIREMENTS
& STANDARDS MANUAL
RESIDENTIAL SERVICES**

ELECTRIC 3.3
RESIDENTIAL SERVICES
SCALE: NONE
DATE: 8.24.07
REV: One (1)
REV DATE: 7.9.13

Underground Electrical Service Point

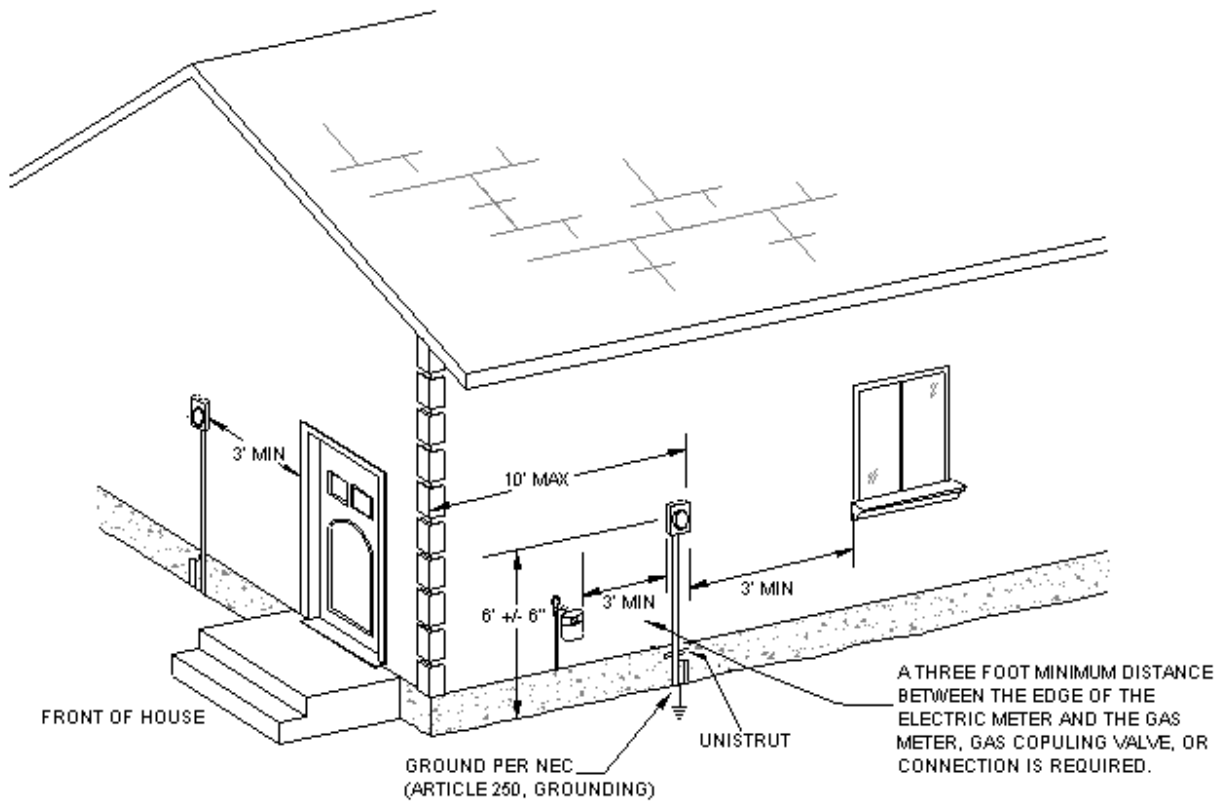

Figure 3 – Residential Meter Location for an Underground Service

Underground service can be provided to the customer from either an overhead or an underground distribution system.

All residential underground services shall be installed in Power Department approved, customer installed conduit per Section 2 of this standards manual. The Power Department will determine and install the appropriate size service conductor from its distribution line to the service point.

The Power Department owns and maintains the underground service lateral from its distribution line to the customer's electrical service point. The Power Department also owns and maintains the meter. The customer owns the meter socket, the meter base, and all wiring beyond the meter socket.

ELECTRIC 3.4

RESIDENTIAL SERVICES

SCALE: NONE

DATE: 8.24.07

REV: One (1)

REV DATE: 7.9.13

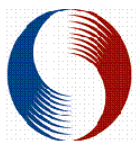

Springville

Community. Service. Reliability.

SPRINGVILLE CITY ELECTRICAL REQUIREMENTS & STANDARDS MANUAL RESIDENTIAL SERVICES

Customer Responsibilities - Single-Family Underground Service Requirements:

Utah Law Section 54-8A-1 through 54-8A-11 requires the Blue Stakes One Call Location Center be notified at least two working days prior to excavation. The excavation must not be started until locations have been made. The trench should be a minimum of 12 inches wide.

The customer shall furnish and install a meter socket suitable for an underground service and provide and install the conduit from the meter socket to the Power Department's point of source. The length of the service should be no more than 150 feet with no more than 360 degrees of total bend in the conduit. The underground conduit shall be Schedule 40 gray PVC. Metallic conduit shall be used above ground from the meter socket to the first 90 degree sweep which shall also be metallic. Below ground metallic conduit must be wrapped with 10 mil corrosion tape suitable for the application. Conduit shall be terminated at the open ends with plastic bushings. The conduit shall be properly glued. A 500-pound test or greater pull line shall be left in the conduit with at least 6 feet of line extending from each end.

Services of 100 to 150 Amps require 2 inch conduit and 200 Amp services require 2 1/2 inch conduit. Call the Power Department for assistance with services greater than 200 Amps.

Prior to backfilling, the customer must notify the Power Department for an inspection. There are two inspections. The first one will be for conduit depth and the conduit must be in the trench. There must be 24 inches of cover from the top of the conduit to the final grade. There must be 4 inches of sand under the conduit unless existing soil is approved by the inspector. Following the inspection the Power Department shall issue a notice to proceed, allowing backfill of sand. A second inspection is required to check for at least 1 foot of sand on top of the conduit and red caution ribbon stating "CAUTION POWER BURIED BELOW" on top of the sand. After the second inspection backfilling may be completed. The trench can have no rocks or foreign material in the backfill other than specified in section 2.7. All trenches shall be backfilled within 48 hours after the conduit is installed.

The customer must identify and remediate all potential surface or subsurface problems that may damage the Power Department's facilities including but not limited to, surface or sub-grade water flows, or frost heaves. The customer shall provide the trench, sand, backfill, compaction, and, where required, surface restoration.

In order for the permanent power to be connected, the main breaker panel cover must be in place on the meter base and secured as designed for the base being used. Also the outside cover must be in place over this cover with at least one screw in each corner. The inside breaker panel must also be covered with at least one screw in each corner of the cover.

Grounding shall be provided according to State adopted electrical codes.



**SPRINGVILLE CITY
ELECTRICAL REQUIREMENTS
& STANDARDS MANUAL
RESIDENTIAL SERVICES**

ELECTRIC 3.5
RESIDENTIAL SERVICES
SCALE: NONE
DATE: 8.24.07
REV: One (1)
REV DATE: 7.9.13

If a compression fitting is used to attach the conduit to the meter base, a bonding bushing and bonding jumper are required. The jumper must go to the customer side of the meter base unless the base is designed to accept the jumper on the utility side, and utilize a hole in the ground bus of its own.

For temporary power while still under construction, a 120 Volt ground fault circuit interrupter must be in place somewhere in the house as required by the NEC. The most practical place to install it is in the laundry room.

On underground installations, there must be a ninety degree elbow in the junction box with a riser that terminates a minimum of three inches above the dirt floor of the junction box and not closer than ten inches from the bottom of the lid.

To prevent the riser from pulling out of the meter base during settling of the ground the conduit must be anchored to the foundation using unistrut, bolts, 3/8 inch minimum anchors, and a unistrut clamp. Corrosion tape must be remove where the clamp is installed to the riser pipe.

The location of the meter base shall be on the side of the house closest to the secondary power source and no more than 10 feet from the front wall. Contact dispatch at (801) 489-2750 Ext. 10 if the power source needs to be located. If no secondary power box is available on the lot contact the power department for further instructions.

The height of the meter base shall be 6 feet plus or minus 6 inches above ground at the center of the meter base opening.

On service changes the old main breaker must be saved for the inspector. Where no increase in amperage is paid for, the same size service must be used. Department policy allows for a maximum impact fee credit of 100 amps for any service that does not have a main breaker installed.

The first two inspections (temporary inspection, trench inspection, permanent power inspection, service change inspection) will be at no cost; all inspections after that will be \$50.00 per inspection.



**SPRINGVILLE CITY
ELECTRICAL REQUIREMENTS
& STANDARDS MANUAL
RESIDENTIAL SERVICES**

ELECTRIC 3.6
RESIDENTIAL SERVICES
SCALE: NONE
DATE: 8.24.07
REV: One (1)
REV DATE: 7.9.13

The following figures show the installation of an underground service extension from the house to a transformer, junction box, and power pole. The customer shall consult the Power Department to determine the conduit location adjacent to a Power Department pole, transformer, or junction box. The Power Department will assist with placement of conduit into Power Department facilities other than secondary junction boxes. Only licensed electrical contractors can access secondary junction boxes.

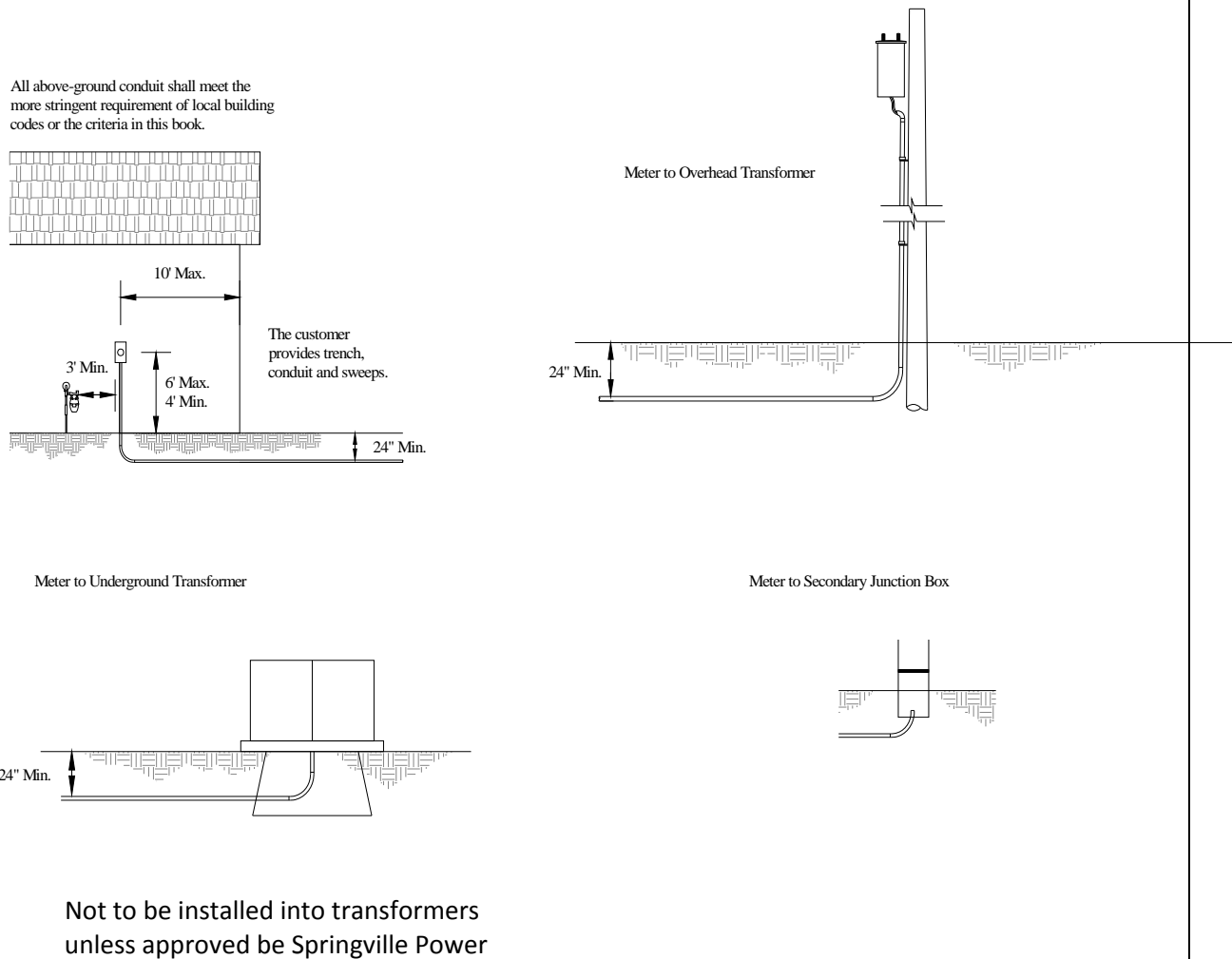
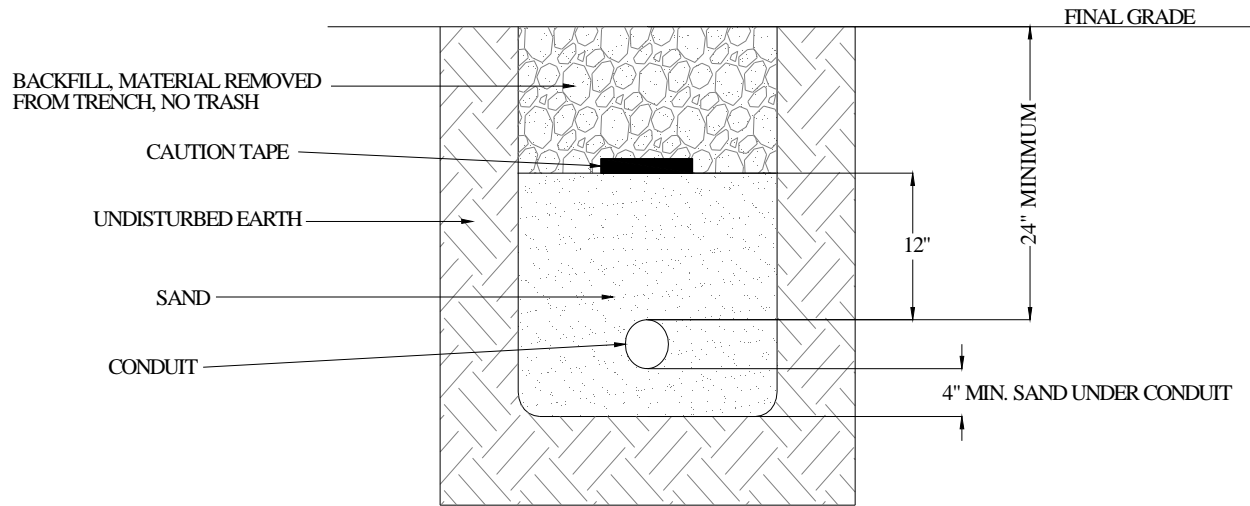

Figure 3 – Installation of Underground Service Extension



SPRINGVILLE CITY
ELECTRICAL REQUIREMENTS
& STANDARDS MANUAL
RESIDENTIAL SERVICES

ELECTRIC 3.7
RESIDENTIAL SERVICES
SCALE: NONE
DATE: 8.24.07
REV: One (1)
REV DATE: 7.9.13







-  UNDISTURBED EARTH
-  BACKFILL COMPACTED TO 95%
-  SAND
-  RED BURIED ELECTRICAL CAUTION (WARNING) TAPE / WEIGHED DOWN EVERY 5-10 FT
-  CONDUIT 2" FOR 150 AMPS & SMALLER, 2.5" CONDUIT FOR 200 AMPS SERVICES

Figure 4 – Service Trench Detail

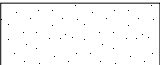

**SPRINGVILLE CITY
ELECTRICAL REQUIREMENTS
& STANDARDS MANUAL
RESIDENTIAL SERVICES**

ELECTRIC 3.8
RESIDENTIAL SERVICES
SCALE: NONE
DATE: 8.24.07
REV: One (1)
REV DATE: 7.9.13

SECONDARY JUNCTION BOXES

Required Secondary Junction Box Types:

1. PenCell AG-14HDXNL
2. Nordic PRMC-150

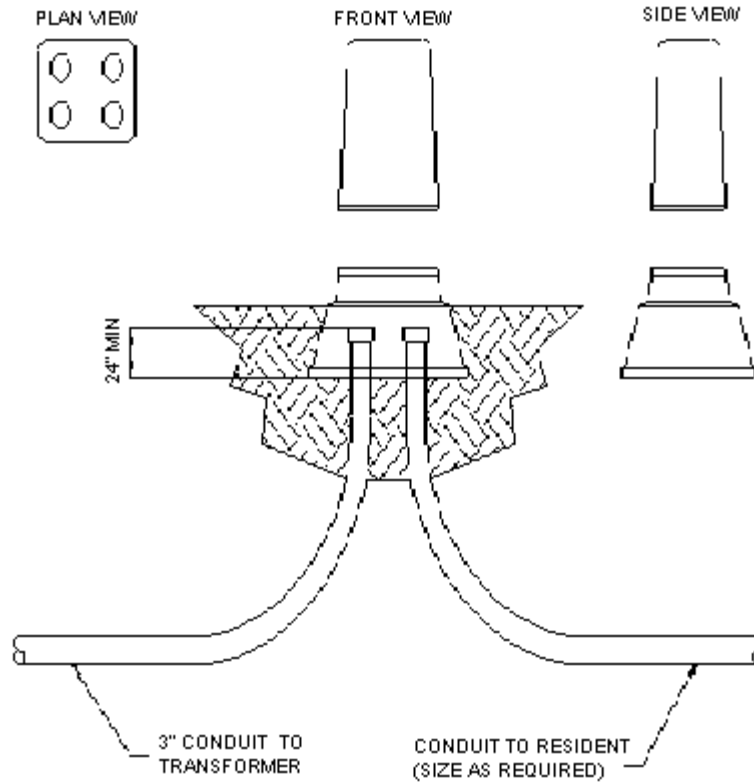

Notes:

1. Springville City Power will provide the secondary junction boxes to the developer.
2. The developer shall provide the minimum spacing between conduits.
3. The developer will seal all conduit ends with tape to prevent plugging.
4. The developer is responsible for trenching and back filling.

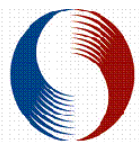

Springville
Community. Service. Reliability.

SPRINGVILLE CITY ELECTRICAL REQUIREMENTS & STANDARDS MANUAL SECONDARY JUNCTION BOXES

ELECTRIC 4.1

SECONDARY JUNCTION BOXES

SCALE: NONE

DATE: 8.24.07

REV:

REV DATE: 7.16.2013

SINGLE-PHASE PAD MOUNTED TRANSFORMERS

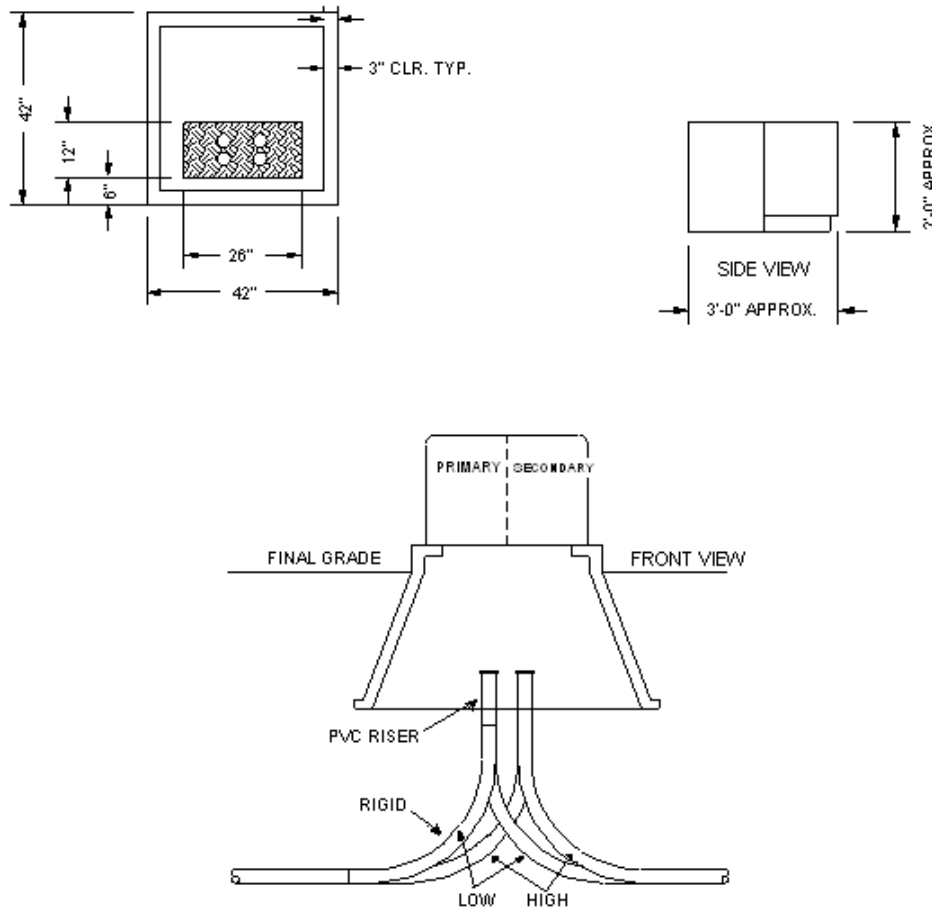

Notes:

1. The developer will supply and install 5/8" X 8' ground rods, and conduit.
2. Springville City Power will supply transformer pads, transformers, and conductors.
3. Plastic couplings are required on all rigid metallic elbows.

Fill material under the primary pad or base shall be road base meeting stat specifications and shall be compacted to 95%. Road base fill shall extend from the bottom of the trench to the transformer pad and shall extend 3 inches on the back and sides and 1 inch on the front.

SINGLE-PHASE TYPICAL CONDUIT INSTALLATION FOR RESIDENTIAL SUBDIVISIONS

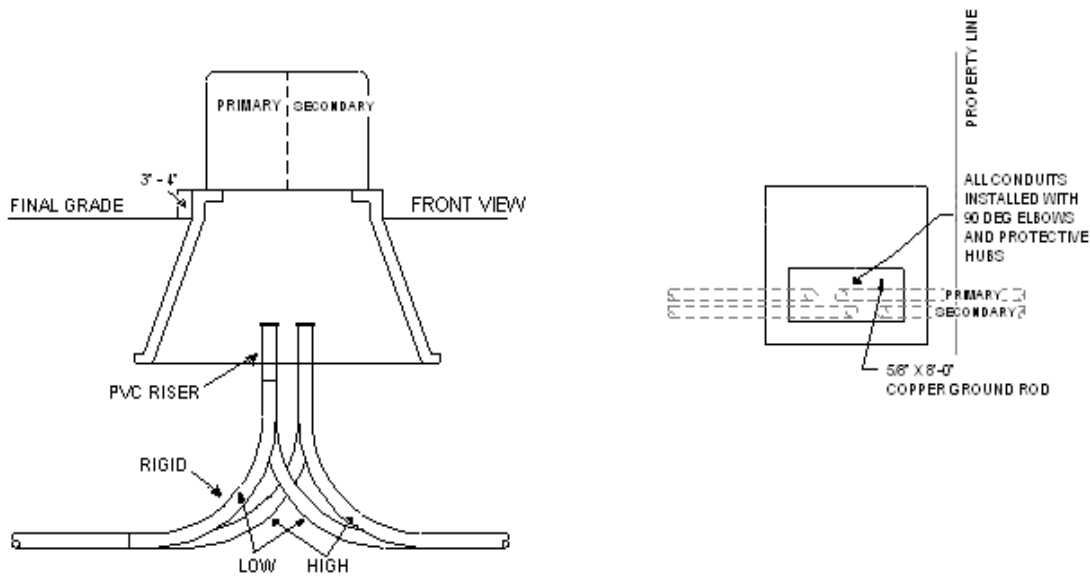

Notes:

1. The developer is responsible for the installation of conduit system as designed and specified.
2. All stub outs must point in the general direction of the front corner of the building and must extend beyond the property line of the lot being served.
3. For residential 200 Amp services use 2 ½ inch conduit and 3 inch conduit from transformers to secondary junction boxes.
4. Conduit for primary cable shall be a minimum of 3 inch. The developer is required to coordinate with the Power Department for the specific conduit sizes required.
5. Conduit sizes from 2 to 4 inches must be 4 feet deep and 6 inch conduit must be 6 feet deep.
6. Rigid conduit shall be used on riser poles and where otherwise specified by the Springville Power Department.
7. All 6 inch conduits shall use rigid steel 90's and fittings and must be wrapped.
8. All secondary conduits shall be stubbed 10 feet beyond the transformer pad where required for future extension of conduit system.
9. In transformer applications all primary conduits must be marked with red paint.



**SPRINGVILLE CITY
ELECTRICAL REQUIREMENTS
& STANDARDS MANUAL
PAD MOUNTED TRANSFORMERS**

ELECTRIC 5.2
PAD MOUNTED TRANSFORMERS
SCALE: NONE
DATE: 8.28.07
REV:
REV DATE: 7.16.13

SINGLE-PHASE TRANSFORMER PAD OR SECONDARY JUNCTION BOX LOCATION WITH PLANTER AND SIDEWALK

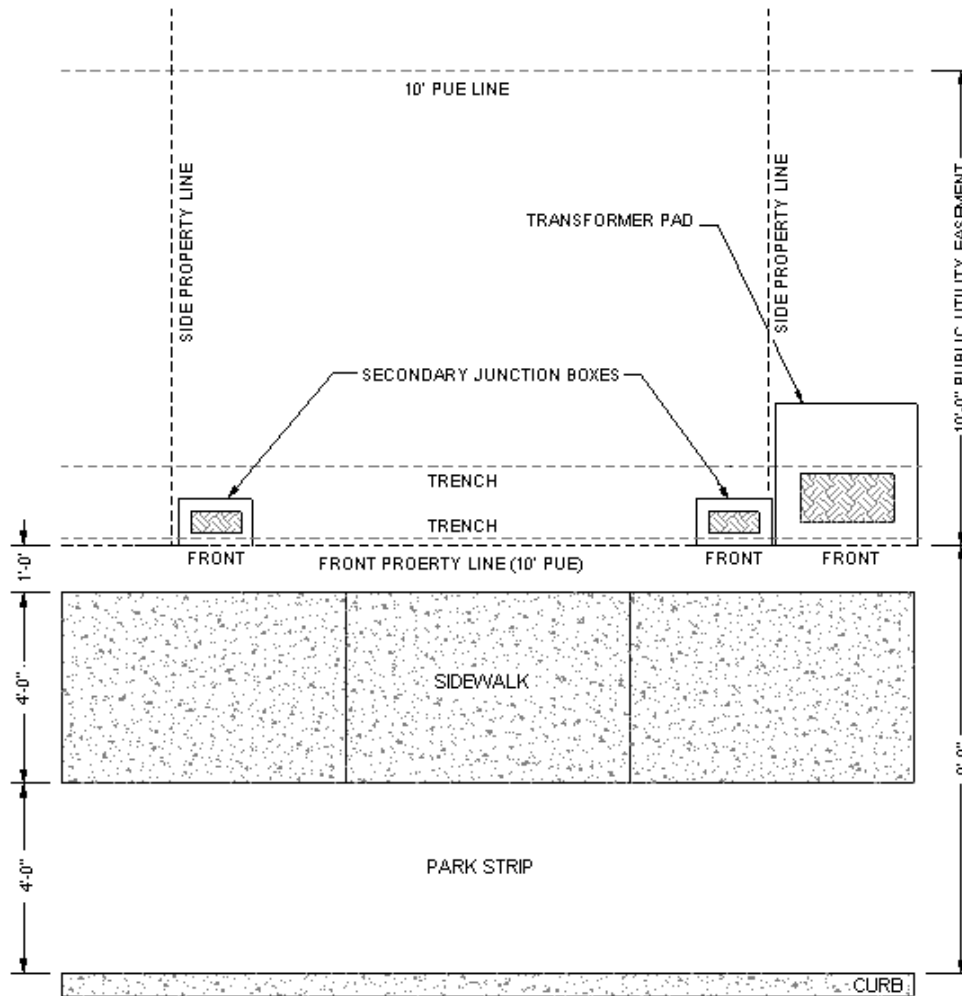

Notes:

1. Transformers and secondary junction boxes are to be offset from the property line on either side.
2. Transformers and secondary junction boxes are to be located as per the electrical design provided by Springville City.
3. Transformer and other equipment must be installed so that the front of the equipment faces the sidewalk. No obstructions are allowed in front of Springville City's power equipment.



SPRINGVILLE CITY ELECTRICAL REQUIREMENTS & STANDARDS MANUAL PAD MOUNTED TRANSFORMERS

ELECTRIC 5.3
PAD MOUNTED TRANSFORMERS
SCALE: NONE
DATE: 8.28.07
REV:
REV DATE: 7.16.13

SINGLE-PHASE AND THREE-PHASE PAD MOUNTED TRANSFORMER CLEARANCES

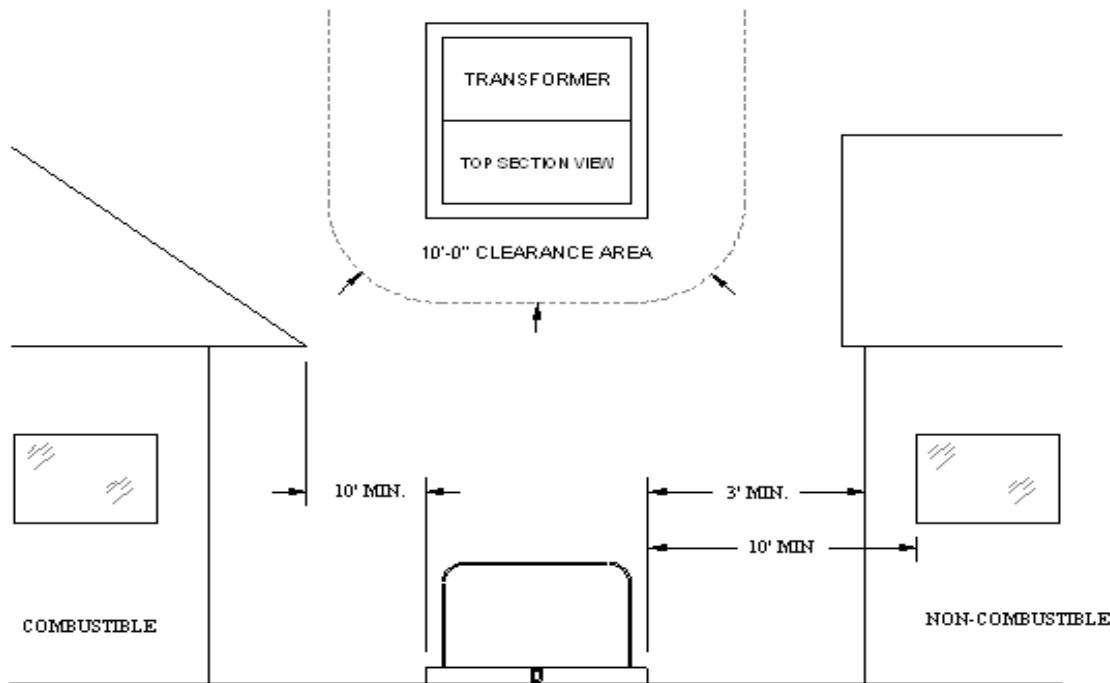

Notes:

1. A 10 foot clear area must be maintained in front of the equipment to allow for the use of hot sticks.
2. The front of pad-mounted transformers must be located away from building walls or other barriers to allow for safe working practices.
3. A 10 foot clearance is required from any transformer surface if the structure is of combustible material.
4. A 3 foot clearance is required to any non-combustible building surfaces that do not have any openings closer than 10 feet.
5. Consult the national electric safety code, NEC, state and local building and fire codes for additional requirements.
6. Consult the Springville Power Department for additional clearances that may be required for doors, windows, fire escapes, air vents, etc.
7. When pad-mounted transformers or other equipment is installed where it may be struck by a motor vehicle the customer will install and maintain Springville Power Department approved barrier posts to protect the equipment.



SPRINGVILLE CITY ELECTRICAL REQUIREMENTS & STANDARDS MANUAL PAD MOUNTED TRANSFORMERS

ELECTRIC 5.4
PAD MOUNTED TRANSFORMERS
SCALE: NONE
DATE: 8.28.07
REV:
REV DATE: 7.16.13

EQUIPMENT EROSION PREVENTION

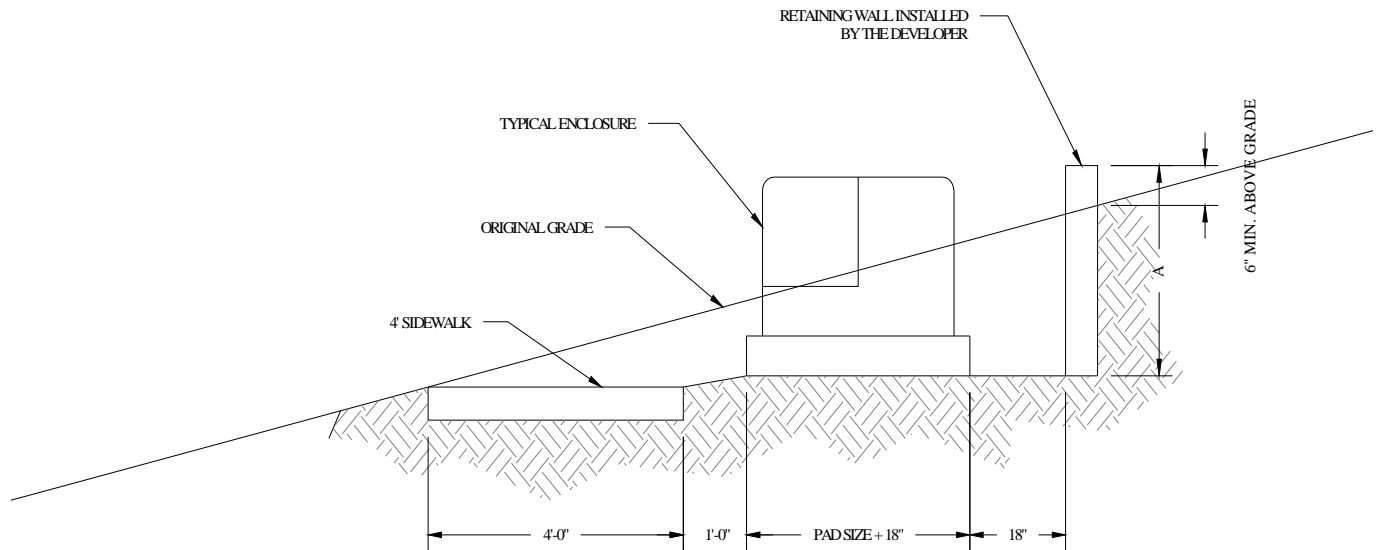

Notes:

1. When it becomes necessary to notch-out or fill a slope to install an enclosure or transformer the cleared area should be of sufficient size to accommodate the enclosure and shorings. The front of the pad shall be placed 2 inches maximum above the sidewalk.
2. The area under and behind the pad must be level and compacted as per the trench specification.
3. A retaining wall is required if dimension "A" is greater than 12 inches.
4. Side retaining walls are also required if dimension "A" is greater than 18 inches. The retaining wall shall be 6 inches above the existing grade and 18 inches from each side and the back of the enclosure.
5. All grading shall be performed by the developer.
6. Contact the Springville Power Department if assistance is required.



**SPRINGVILLE CITY
ELECTRICAL REQUIREMENTS
& STANDARDS MANUAL
PAD MOUNTED TRANSFORMERS**

ELECTRIC 5.5
PAD MOUNTED TRANSFORMERS
SCALE: NONE
DATE: 8.28.07
REV:
REV DATE: 7.16.13

THREE-PHASE TRANSFORMER CONCRETE PAD WITHOUT CT RACK

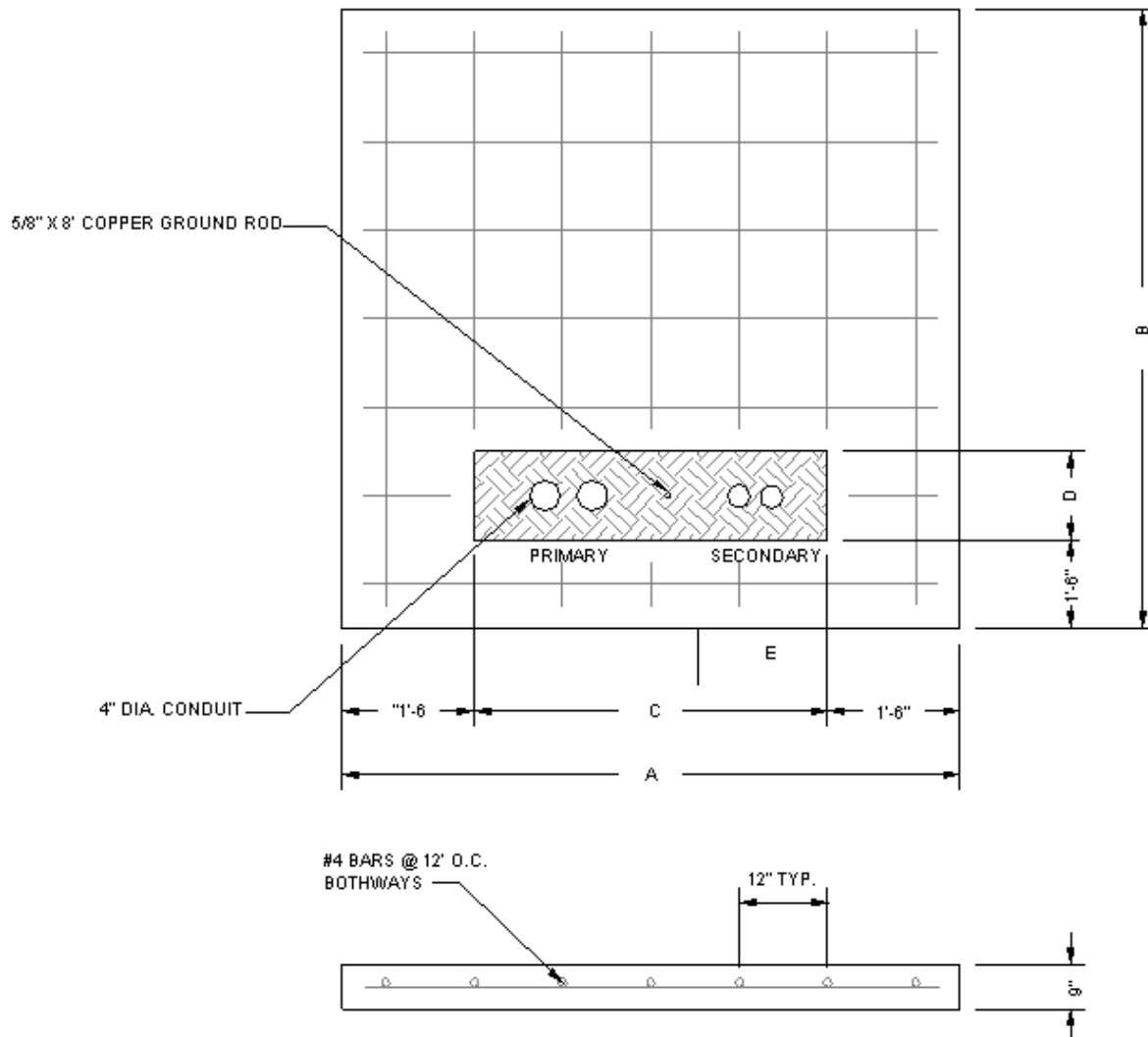

Transformer Pad Dimensions

Transformer Rating	Dimensions				
	A	B	C	D	E
75 – 500 KVA	78"	84"	42"	15"	20"
750 – 2500 KVA	96"	96"	60"	16"	30"

THREE-PHASE TRANSFORMER PAD WITH METERING STATION

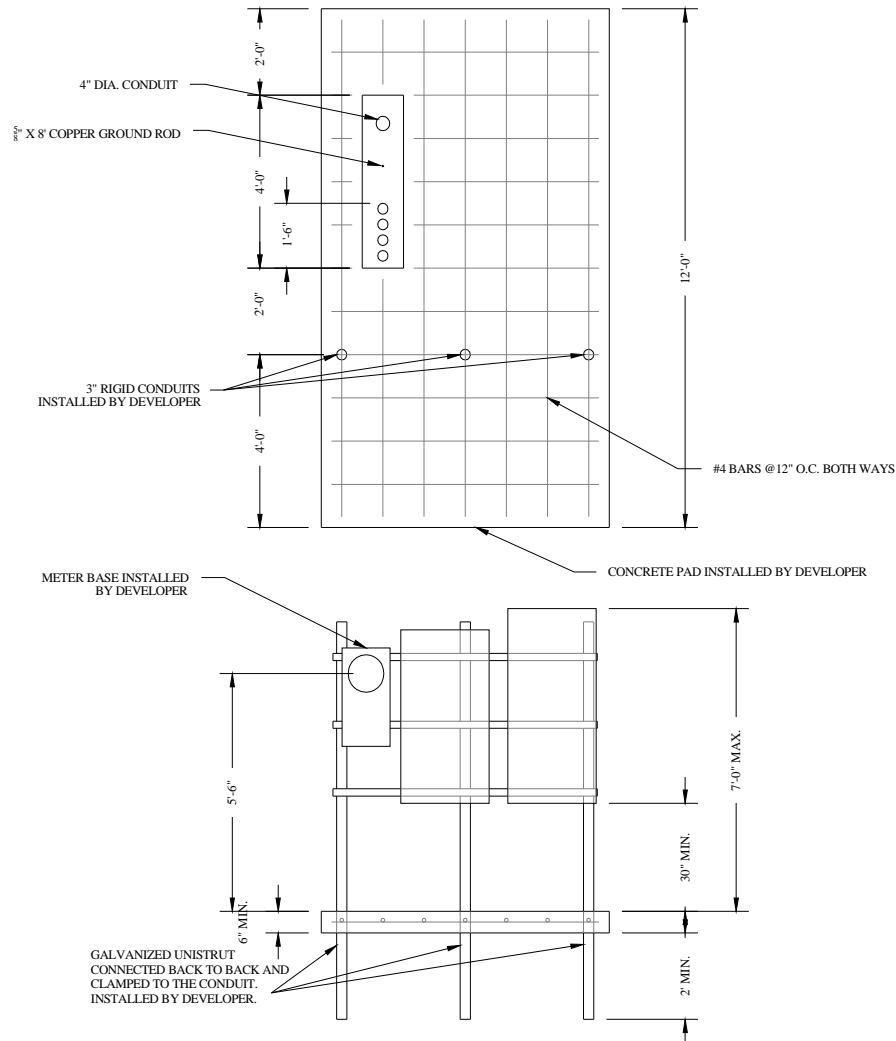

Notes:

1. Springville City will not pull or terminate commercial services from the secondary side of the transformer.
2. The developer shall terminate all cables in the CT cans.
3. The contractor shall terminate all cables they run and provide lugs for the transformer secondary.

STREET LIGHTING

General

The following general requirements shall apply to street lights installed in new underground residential subdivisions or developments located within the service area of Springville City Power (within Springville City):

Springville City Power will provide electric power for street lights at no cost, except as otherwise provided below in the Street Light Layouts section.

Springville City Power standard street lights (poles, fixtures and wiring) shall be used except as provided below. Standard SCP pole is 35' bronze fiberglass pole, 8' bronze arm, with 30 or 80 pack LED fixture. Depending upon location.

Springville City Power standard street lights will be installed in accordance with Springville City Power's Line Extension Policy.

Springville City Power standard street lighting will be installed, owned and maintained by the Springville City Power Department. Conduit systems for street lighting wiring shall be installed by contractors or developers.

With Power Department approval, development specific decorative (non Springville City Power standard) street lighting (poles, fixtures and wiring) may be installed in subdivisions.

Decorative lighting (service disconnect, poles, luminaries, lamps, conduit and wiring) installed in underground subdivisions shall be installed by contractors or developers. Power and maintenance for the street lights will be provided by Springville City Power in accordance with the second paragraph above.

Street Light Layouts

The following layout requirements shall apply to Springville City Power standard and decorative street lighting installations:

Layouts for Springville City Power standard street light installations will be prepared by Springville City Power.

Layouts for decorative street light installations shall be prepared by contractors or developers utilizing the general requirements included in this section. Contractors or developers shall provide drawings of proposed layouts for decorative street lighting to Springville City Power for review and approval. Catalog information on the poles, luminaries and lamps proposed for use shall be provided by contractors or developers with the lighting layouts.



SPRINGVILLE CITY ELECTRICAL REQUIREMENTS & STANDARDS MANUAL STREET LIGHTING

ELECTRIC 6.1
STREET LIGHTING
SCALE: NONE
DATE: 8.21.07
REV:
REV DATE: 7.16.2013

In general, street lights shall be placed at three and four way intersections, and at 90 degree turns. See Figure 1 for a typical street lighting layout.

Street lights shall also be installed between intersections at a staggered spacing of approximately 300 feet to 400 feet. Decorative street lights may be installed at lesser intervals. See Figure 1 for a typical street lighting layout.

Decorative street lights may be installed (300 foot to 400 foot non-staggered spacing) on medians (islands) in streets with islands at least 10 feet in width. Decorative street lights may be installed at lesser intervals.

Luminaries for decorative street lights shall be Type III, include a photo cell receptacle and shall be suitable for use with a LED. Use of luminaries with higher wattage lamps or other light sources (metal halide) must be approved by Springville City Power. House side shields shall be provided if required. Street light poles shall provide a minimum mounting height for luminaries of 16 feet for decorative lighting.

Point(s) of Delivery for Decorative Lighting

The point(s) of delivery for decorative street lights shall be at a location(s) approved by Springville City Power. Contractors or developers shall provide drawings of proposed locations for points of delivery for decorative street lighting to the Springville City Power for review and approval. These points of delivery shall typically be proximate to Springville City Power owned pad mounted transformers or secondary junction boxes. The layout of decorative lights shall be so as to minimize the number of delivery points required.

All points of delivery for decorative street lights shall include a disconnect switch with over current protective device(s) [fuse(s) or breaker(s)]. The rating of the over current protection shall be compatible with the current rating of the wiring connected to the device. The disconnect equipment shall be service entrance rated, tamper proof, equipped with provisions for locking, installed in a NEMA 3R enclosure, and mounted on a building wall or substantial wood or steel post. The disconnect switch and appurtenant facilities shall be installed in accordance with the applicable articles of the National Electric Code (NEC).

Facilities installed at decorative street light points of delivery shall be inspected by the Springville City electrical inspector prior to connection to the Springville City Power electrical system.

Wiring between Springville City Power pad mounting transformers or secondary junction boxes for decorative lighting will be installed, owned and maintained by Springville City Power and installed in conduits (source side conduit systems) provided (furnished and installed) by contractors or developers. Springville City Power will own and maintain the conduits after the street light installation is completed.



**SPRINGVILLE CITY
ELECTRICAL REQUIREMENTS
& STANDARDS MANUAL
STREET LIGHTING**

ELECTRIC 6.2
STREET LIGHTING
SCALE: NONE
DATE: 8.21.07
REV:
REV DATE: 7.16.2013

Street Lighting Conduit Requirements

Springville City Power wiring for Springville City Power standard and decorative street lights shall be installed in direct buried conduit. The contractor or developer shall be responsible for the installation of street lighting conduit systems (2 inch diameter) extending from transformer or secondary junction boxes to lighting fixture locations. Where possible, lighting fixtures shall be located at street intersections and have a maximum spacing of approximately 400 feet. See Figure 1 for a typical street lighting layout. The contractor is responsible for proper location and centering of conduit end points for lighting fixture installations. The City, under the terms of its Line Extension Policy, shall furnish and install lighting fixtures and light fixture service cables.

Commercial areas shall be required to place conduit to light city streets bordering their development. Lights shall be paid for by the Developer and installed by the Power Department. Light placement shall be at each intersection and one for every 150 feet as approved by the Power Department. Light type and size shall be determined by the Power Department according to road size and area.

Springville City Power Standard Street Lights:

Contractors or developers shall provide (purchase and install) all street lighting conduit systems (conduit, fitting, elbows, conduit cement, etc.) for Springville City Power standard street lights. Springville City Power will own and maintain the conduit systems after the street light installation is completed. The conduit systems shall extend from Springville City Power pad mounted transformers or secondary junction boxes to street light locations. The contractor or developer shall be responsible for proper routing and placement (burial depth, excavation, bedding, backfill and compaction) of conduit and for the location of conduit end points (stub ups) at pad mounted transformers and/or secondary junction boxes, and street light locations.

Decorative Street Lights:

Contractors or developers shall provide (purchase and install) conduit systems between decorative street light delivery points and Springville City Power pad mounted transformers and/or secondary junction boxes. Springville City Power will own and maintain the conduit systems after the street light installation is completed. The contractor or developer shall be responsible for proper routing and placement of conduits, and for the location of conduit end points (stub ups) at pad mounted transformer or secondary junction box locations. Springville City Power will install the wiring from transformer or secondary junction box to the delivery point and terminate the wiring at the street light. Conduit types and capping shall be in accordance with the conduits paragraphs of this document.



SPRINGVILLE CITY ELECTRICAL REQUIREMENTS & STANDARDS MANUAL STREET LIGHTING

ELECTRIC 6.3
STREET LIGHTING
SCALE: NONE
DATE: 8.21.07
REV:
REV DATE: 7.16.2013

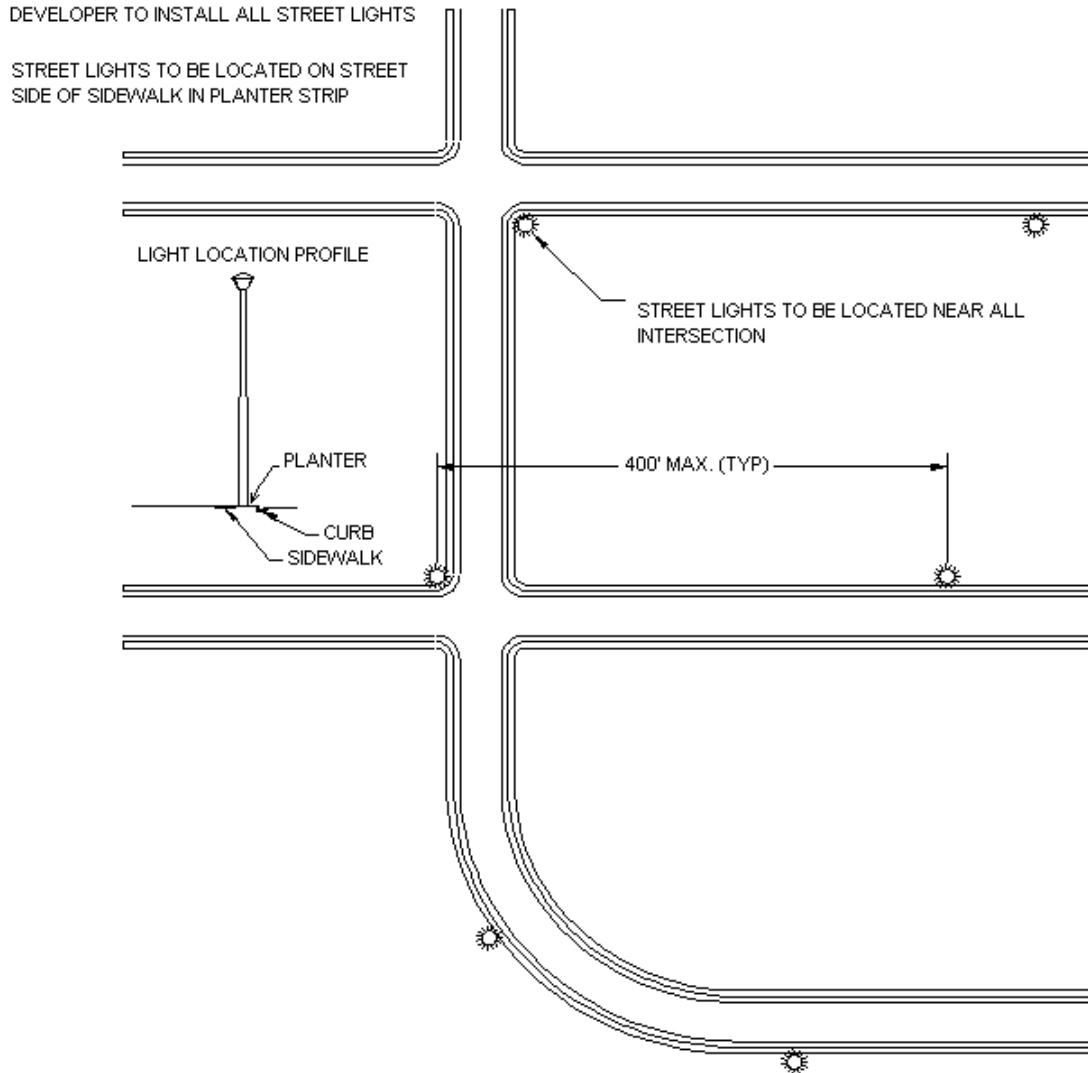

Notes:

1. The lighting design and layout shall be provided by Springville City.
2. Inspection of street lighting shall be scheduled at the same time as the depth of system and compaction inspections.

Figure 1 – Typical Street Lighting Layout

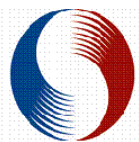

Springville
Community. Service. Reliability.

**SPRINGVILLE CITY
ELECTRICAL REQUIREMENTS
& STANDARDS MANUAL
STREET LIGHTING**

ELECTRIC 6.4
STREET LIGHTING
SCALE: NONE
DATE: 8.21.07
REV:
REV DATE: 7.16.2013

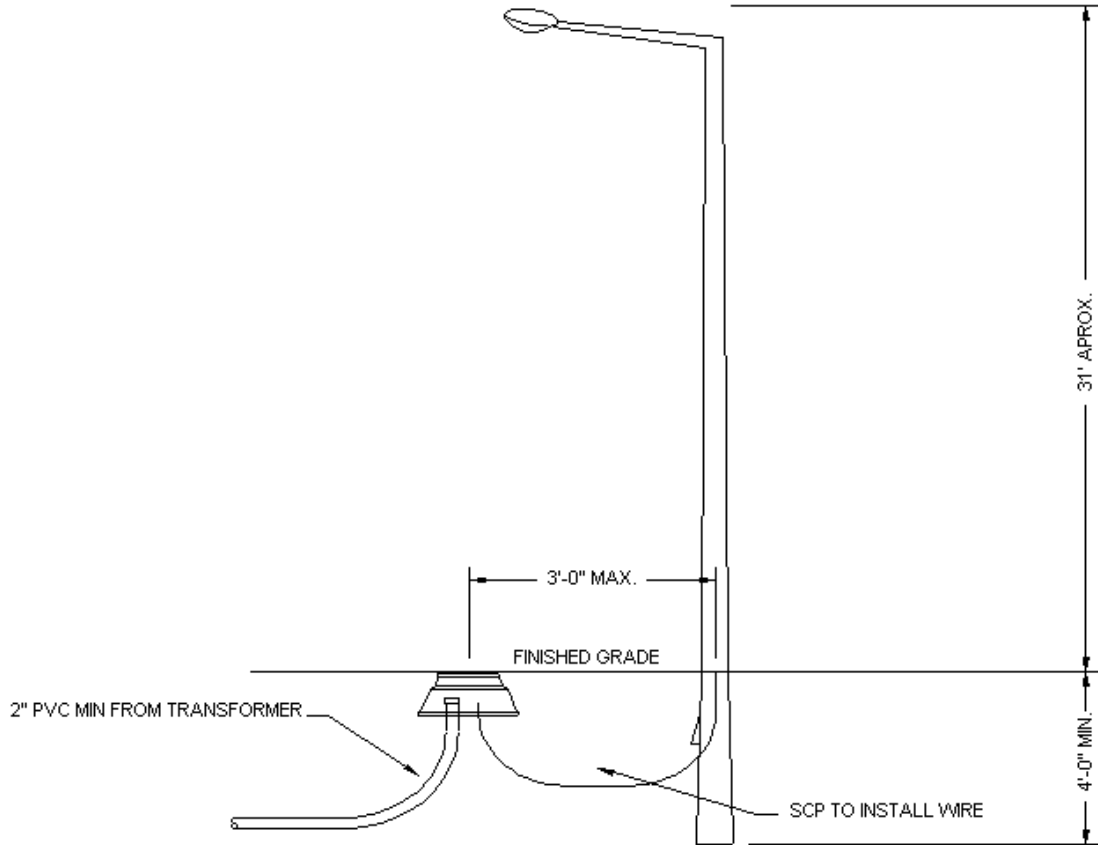

Notes:

1. The developer shall provide 2 inch conduit from the transformer to the secondary junction box.
2. Springville City Power will provide a lockable secondary junction box.
3. Springville City Power shall provide wire from the secondary junction box to the light pole.
4. Required secondary junction box will be provided for installation to the developer.

Figure 2 – Street Light Wiring

SECTIONALIZERS AND SWITCHES CONDUIT PLACEMENT FOR SECTIONALIZERS

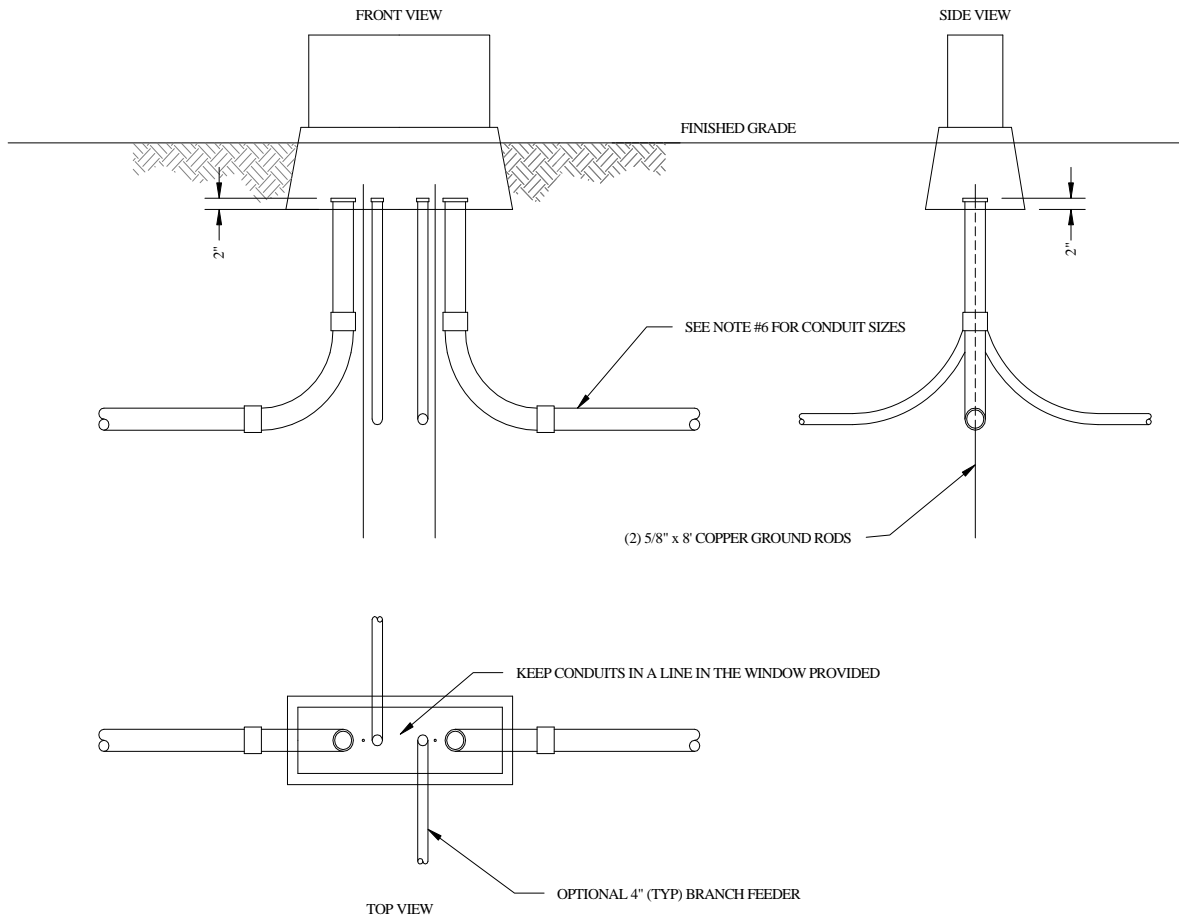

Notes:

1. All 90 degree elbows shall be rigid steel and PVC wrapped.
2. Bases will be provided by Springville City and installed by the Developer.
3. The developer shall provide and install all ground rods (5/8" x 8' copper clad steel) and subsequent materials to complete the installation.
4. Conduit sizes and locations will be provided by Springville city on the subdivision electrical plans.
5. Support all conduits during backfilling keeping them as vertical as possible.



SPRINGVILLE CITY ELECTRICAL REQUIREMENTS & STANDARDS MANUAL SECTIONALIZERS AND SWITCHES

ELECTRIC 7.1
SECTIONALIZERS AND SWITCHES
SCALE: NONE
DATE: 8.28.07
REV:
REV DATE: 7.16.13

SECTIONALIZERS AND SWITCHES CONDUIT PLACEMENT FOR SWITCHES

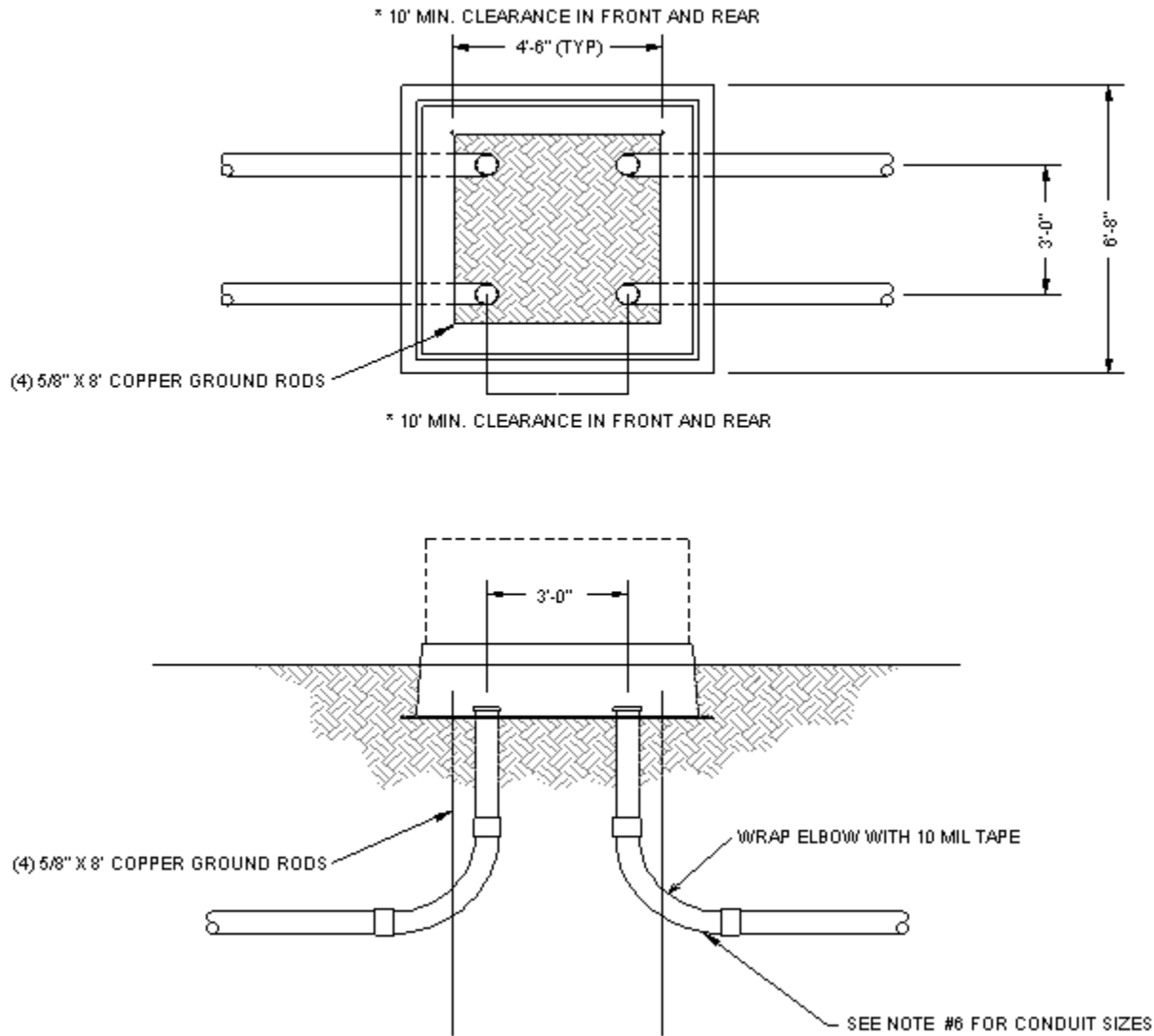

Notes:

1. All 90 degree elbows shall be rigid steel and PVC wrapped.
2. Bases will be provided by Springville City and installed by the developer.
3. The developer shall provide and install all ground rods (5/8" x 8' copper clad steel) and subsequent materials to complete the installation.
4. Conduit sizes and locations will be provided by Springville City on the subdivision electrical plans.
5. Support all conduits during backfilling keeping them as vertical as possible.



SPRINGVILLE CITY ELECTRICAL REQUIREMENTS & STANDARDS MANUAL SECTIONALIZERS AND SWITCHES

ELECTRIC 7.2
SECTIONALIZERS AND SWITCHES
SCALE: NONE
DATE: 8.28.07
REV:
REV DATE: 7.16.13

DEVELOPER OVERVIEW

SCOPE

The purpose of this standard is to give a general overview of the most important rules set forth by the Springville City Power Department (SCP). This standard is only meant to give developers, contractors and individuals basic guidelines; further reading in this manual will be required to obtain the information needed.

BASIC GUIDLINES

1. Primary circuits to be buried at 48 inches to the top of conduit from final grade.
2. Secondary lines to be buried at 24 inches to the top of conduit, except when in a joint trench.
3. Services to be buried at 24 inches to the top of conduit.
4. All meters to be placed within 10 feet of the front of the house on the side closest to power source. The power source is defined as a transformer or secondary box.
5. SCP to supply all transformers, conductors, switches and secondary boxes; the developer or contractor will pay SCP for this equipment as per Resolution 97-12.
6. All primary conduit rigid wrapped elbow sweeps to be a minimum of 36-inch radius.
7. Transformer basements, ground sleeve basements, and secondary boxes to be graveled with 1 inch minus gravel.
8. The first two trench inspections will be at no cost; all inspections after that will be \$50.00 per inspection.
9. Inspections must take place before the trench is backfilled (2 trench inspections required).
 - a) Trench depth and conduit depth inspection.
 - b) Sand and tape inspection.
10. Secondary riser poles will have weather heads.
11. No meter bases will be allowed on SCP service poles or primary line poles.
12. Riser poles to have rigid 36 degree sweeps and metallic conduit the entire length of the riser.
13. All conduits to be schedule 40 or better.

	<p>SPRINGVILLE CITY ELECTRICAL REQUIREMENTS & STANDARDS MANUAL DEVELOPER OVERVIEW</p>	ELECTRIC 8.1
	DEVELOPER OVERVIEW	
	SCALE: NONE	
	DATE: 8.08.07	
	REV:	
	REV DATE: 7.16.2013	

TEMPORARY POWER / SERVICE

1. Place the temporary pedestal 2 to 3 feet off the corner of the junction box at a 45 degree angle to the sides to avoid hitting conduit going to and from the junction box. The pedestal should be buried deep enough that it won't fall over if a man were to push on it. Temporary services may not be placed on utility poles. For a temporary aerial service pedestal, contractor will need to contact SCP for placement.
2. Use direct burial cable in conduit going down tout of the pedestal into the ground. The cable trench should allow for at least 24 inches of cover over the cable. Once inside the junction box there should be 3 feet of cable coiled up to make the connection. Transformers require 4 feet.
3. The wires must be stubbed into the junction boxes for connection to be made.
- 4. Only if there is not secondary power in the lot may the contractor stub into a transformer, (contact electric department for placement and opening of transformers).**
5. A copper clad steel ground rod measuring 5/8 inch x 8 foot must be used (Blue Stake request is suggested before installing). In rocky soil it may be angled up to 45 degrees. It should be driven all the way in, with a slight hole around the top so the inspector can see the ground wire, clamp, and rod. The wire should be between the back side of the clamp and the rod, not under the screw. The ground wire shall be #6 copper wire or equivalent, or larger.
6. Only a ground rod clamp will be accepted for ground wire to rod connection.
7. Ground wire is not to be spliced.
8. All outlets shall be GFCI protected, and have weather proof covers.
9. All covers must be in place and stay in place while the temporary pedestal is energized.
10. The meter base cover shall be weather proof, and shall be fastened in place with all screws provided by the manufacturer.
11. No altering of the temporary pedestal base is permitted.
12. Temporary pedestals are not allowed to be set on houses, businesses, or on the power department's utility poles.
13. Neutrals must be bonded to the ground wire.
14. Underground temporary pedestals set further than 5 feet away from the source will follow the trench requirements.



SPRINGVILLE CITY ELECTRICAL REQUIREMENTS & STANDARDS MANUAL TEMPORARY POWER / SERVICE

ELECTRIC 9.1
TEMPORARY POWER / SERVICE
SCALE: NONE
DATE: 8.08.07
REV:
REV DATE: 7.16.2013

15. Any temporary pedestal with physical damage or if deemed unsafe will not be connected and/or may be disconnected.
16. All outlets exposed to the weather will be required to have weatherproof covers.
17. No underground temporary pedestals will exceed the 200 Amp rating.
18. Temporary pedestals are not to be in place longer than 365 days. Department reserves the right to remove temporary meter or require additional fees if temporary pedestal is in place past 365 day limit.
19. No aerial temporary pedestals will exceed 150 Amp rating.
20. Aerial temporary pedestals must be supported to keep the structure from swaying.
21. Aerial temporary pedestals must have enough wire to make the connection at the pole.
22. Aerial temporary pedestals are to have at least a 2 inch mast with a weather head.
23. The first two temporary inspections will be at no cost; all inspections after that will be \$50.00 per inspection.



**SPRINGVILLE CITY
ELECTRICAL REQUIREMENTS
& STANDARDS MANUAL
TEMPORARY POWER / SERVICE**

ELECTRIC 9.2
TEMPORARY POWER / SERVICE
SCALE: NONE
DATE: 8.08.07
REV:
REV DATE: 7.16.2013

RESIDENTIAL ELECTRICAL INSPECTION REQUIREMENTS

1. The trench can have no rocks or foreign material in the backfill. Bedding is required for each trench. There are two inspections. The first one will be for conduit depth. The conduit must be in the trench. There has to be 24 inches of cover from the top of the conduit to finish grade. The second inspection will be for 12 inches of bedding above the conduit and red electrical caution tape on top of the bedding. Bedding is defined as sand.
2. Conduit must be a minimum of 2 inches inside diameter for services of 150 Amps or less, and 2 1/2 inches inside diameter for 200 Amp services. Electrical PVC conduit is acceptable underground. Any conduit that is open to the air must be rigid or intermediate metallic conduit (IMC). Rigid and IMC that is underground must be wrapped with corrosion proof tape. Meter bases must be used as intended, modifications will not be accepted. Examples: modifying existing knock outs or the addition of knock outs.
3. On underground installations, the 90 degree elbow at the house must be rigid, and wrapped with corrosion proof tape.
4. In order for the permanent power to be connected, the main breaker panel cover must be in place on the meter base, secured as designed for the base being used. Also the outside cover must be in place over this cover with at least one screw in each corner. There must be a disconnect switch at the meter base.
5. The inside breaker panel must also be covered, with at least one screw in each corner of the cover.
6. A 500-pound test or greater pull line shall be left in the conduit with at least 6 feet of line extending from each end.
7. Grounding shall be done according to the current adopted State electrical codes.
10. If a compression fitting is used to attach the conduit to the meter base, a bonding bushing and bonding jumper are required. The jumper must go to the customer side of the meter base, unless the base is designed to accept the jumper on the utility side, and utilize a hole in the ground bus of its own.
11. A 120 Volt GFCI must be in place somewhere in the house as required by the NEC. The most practical place to install it is in the laundry room or kitchen.
12. On underground installations, there must be a 90 degree elbow in the junction box with a riser that terminates a minimum of 3 inches above the dirt floor of the junction box and not closer than 10 inches from the bottom of the lid. If the edges of the opening of the conduit

	<p>SPRINGVILLE CITY ELECTRICAL REQUIREMENTS & STANDARDS MANUAL ELECTRICAL INSPECTION</p>	ELECTRIC 10.1
		ELECTRICAL INSPECTION
		SCALE: NONE
		DATE: 8.21.07
		REV:
		REV DATE: 7.16.13

are sharp enough to skin the insulation of the wire being pulled, it must have a smooth bushing on it to protect the wire.

13. To prevent the riser pulling out of the meter base during settling of the ground, the conduit must be anchored to the foundation using unistrut, 3/8 inch bolts and anchors, and a unistrut clamp.
14. The location of the meter base shall be on the side of the house closest to the power source and no more than 10 feet from the front wall. Base must be located in from of any fence constructed on property to meet accessibility requirements. Contact dispatch at 489-2750 Ext. 10 if the power source needs to be located.
15. The height of the meter base shall be 6 feet, plus or minus 12 inches at the center of the meter opening.
16. On service changes, the old main breaker must be saved for the inspector. Where no increase in amperage is paid for, the same size service must be used.

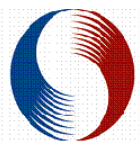

Springville
Community. Service. Reliability.

**SPRINGVILLE CITY
ELECTRICAL REQUIREMENTS
& STANDARDS MANUAL
ELECTRICAL INSPECTION**

ELECTRIC 10.2
ELECTRICAL INSPECTION
SCALE: NONE
DATE: 8.21.07
REV:
REV DATE: 7.16.13